

FI Varaosakirja
EN Spare parts list

Palax KS 35 Ergo

Palax KS 35 s



Sarjanumero _____

Valmistusvuosi _____

PALAX
Lahdentie 9
61400 Ylistaro, FINLAND
Tel. +358 6 4745100
Fax. +358 6 4740790
www.palax.fi

FI Tilausohje 19...22

Etsi kuva jossa haluamasi osa on.

Katso kuvasta osan numero.

Katso osaluettelosta kuvanumeron ja osanumeron avulla tilausnumero.

Tilauksessa mainittava aina tilausnumero, osan nimi, koneen sarjanumero ja valmistusvuosi.

EN Ordering guide 23...26

Seek the right picture.

See the part number.

Look, by using the picture- and partnumber for the right orderingnumber of the sparepart from the spareparts list.

When ordering always mention the sparepart number, partname, serialnumber and manufacturing year.

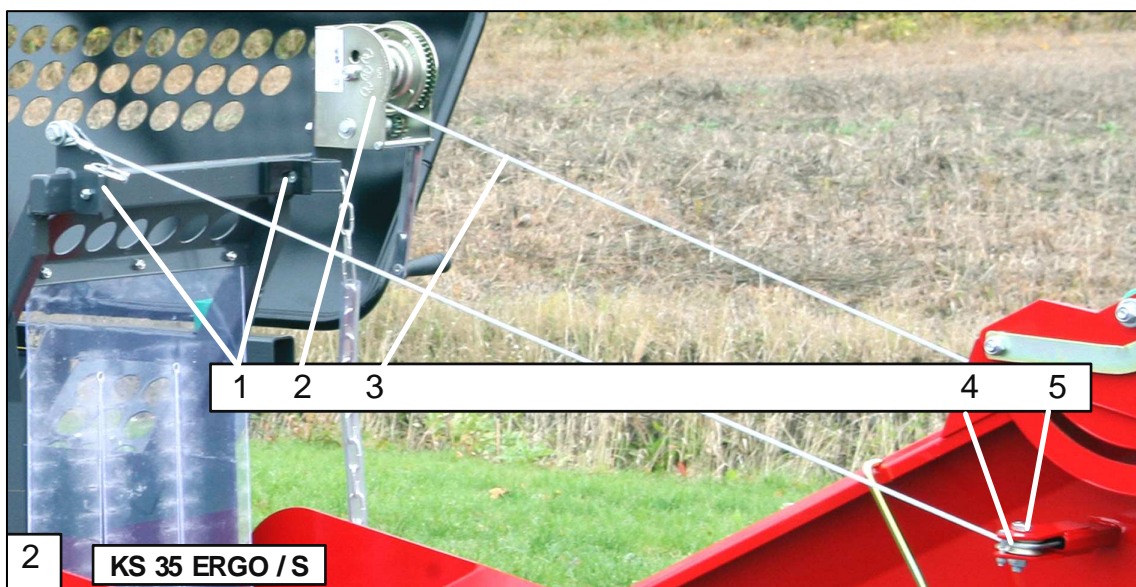

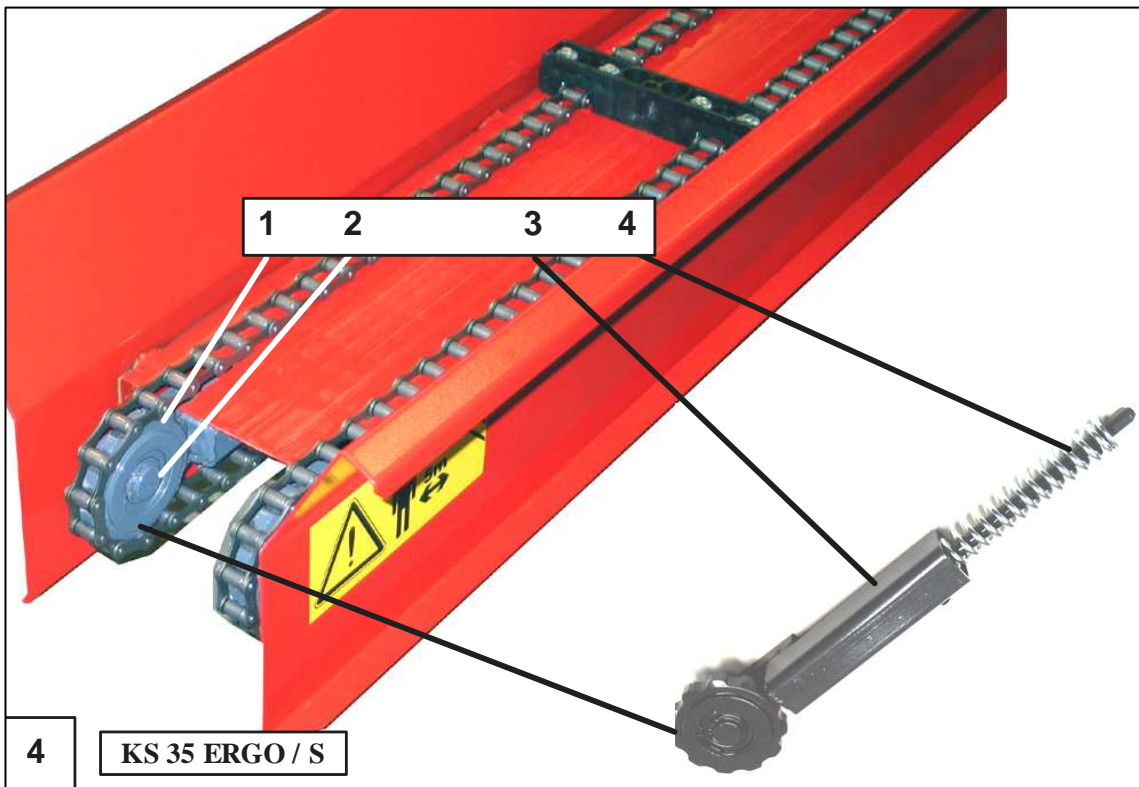
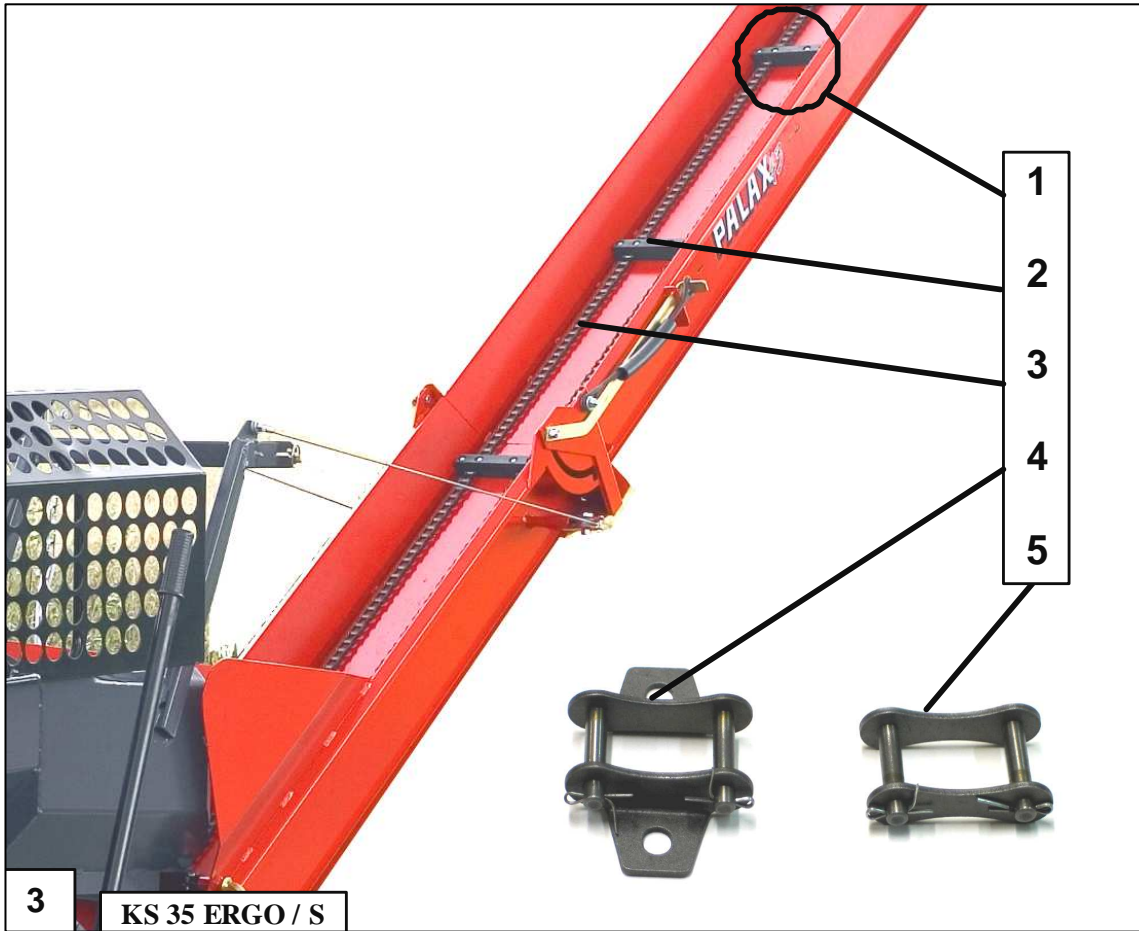

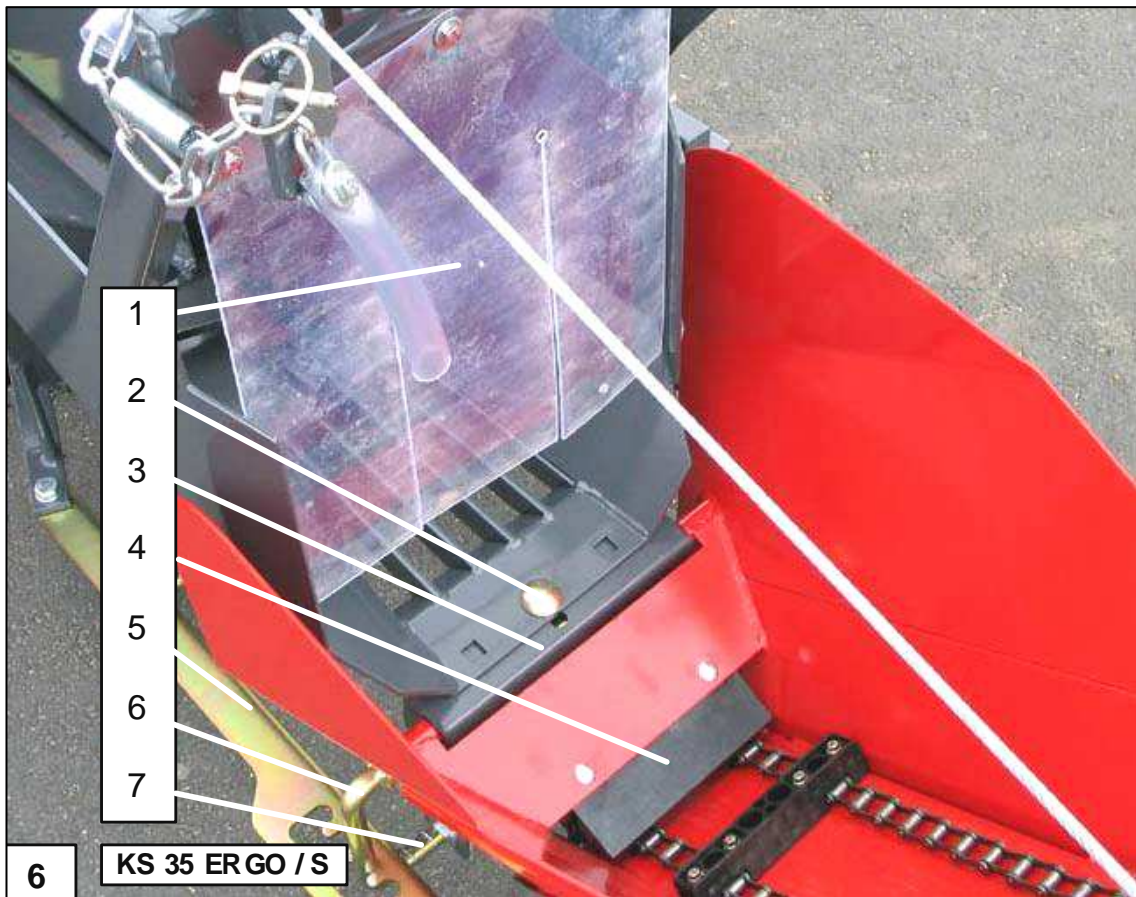
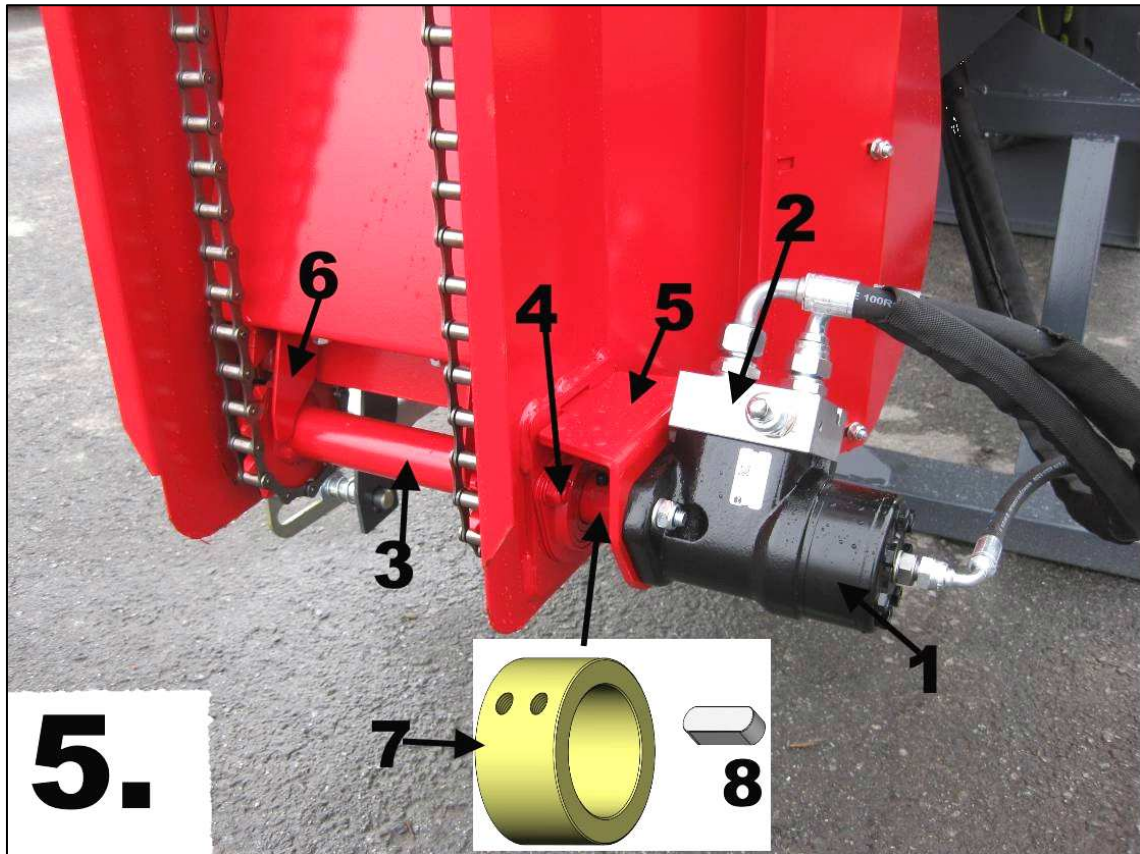

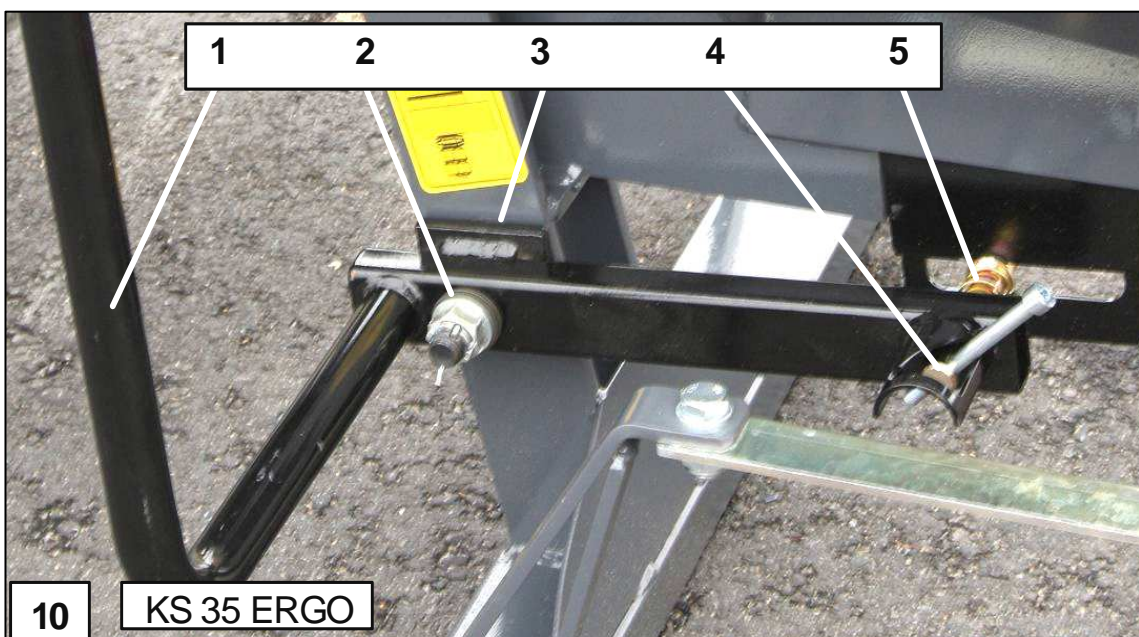
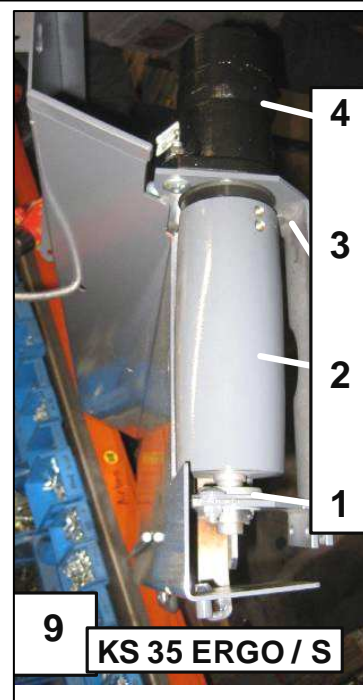
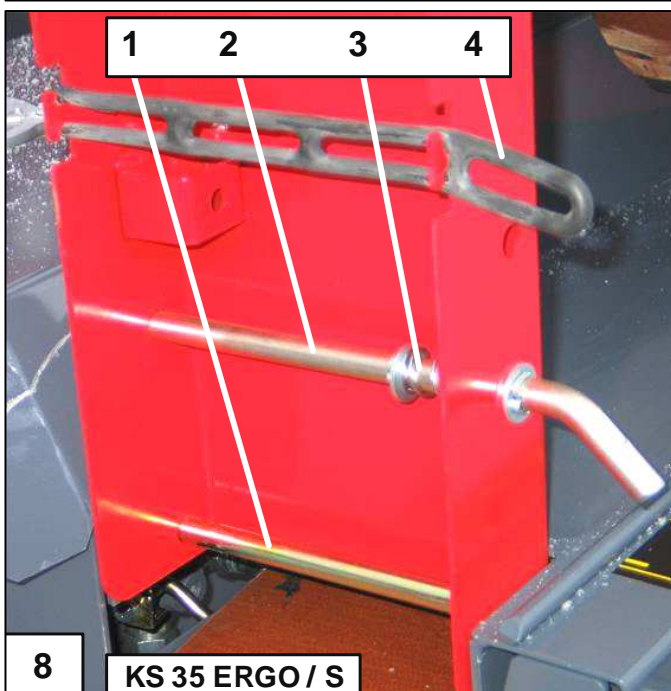
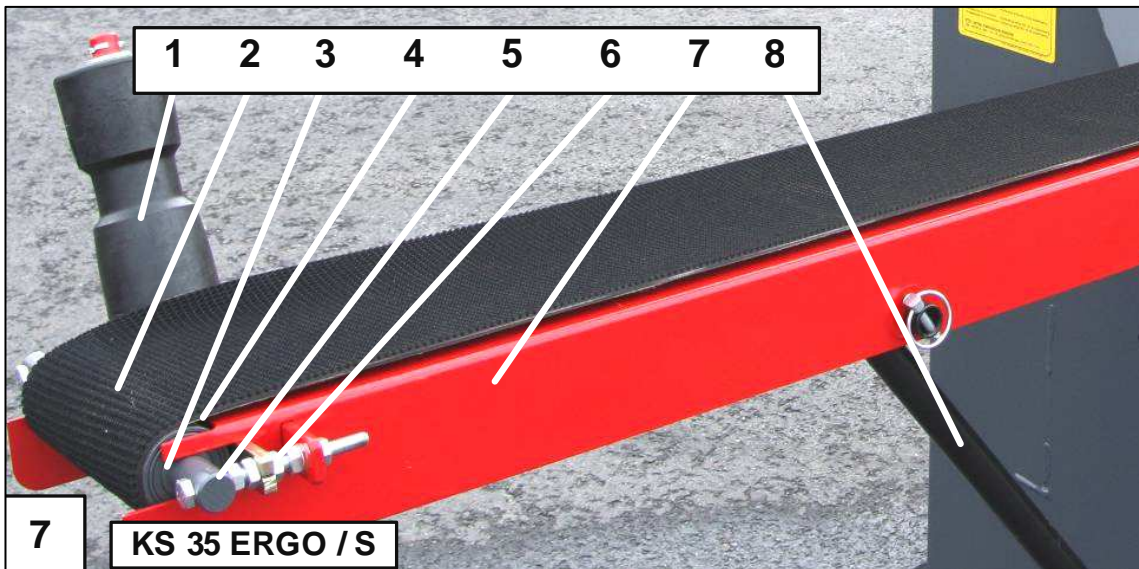

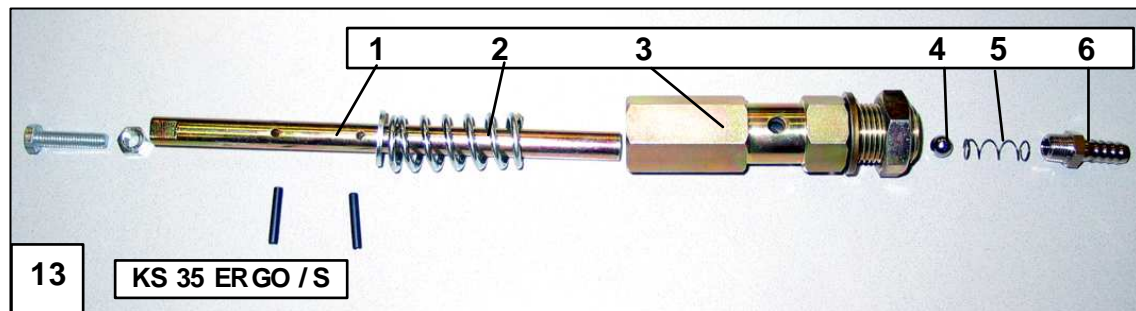
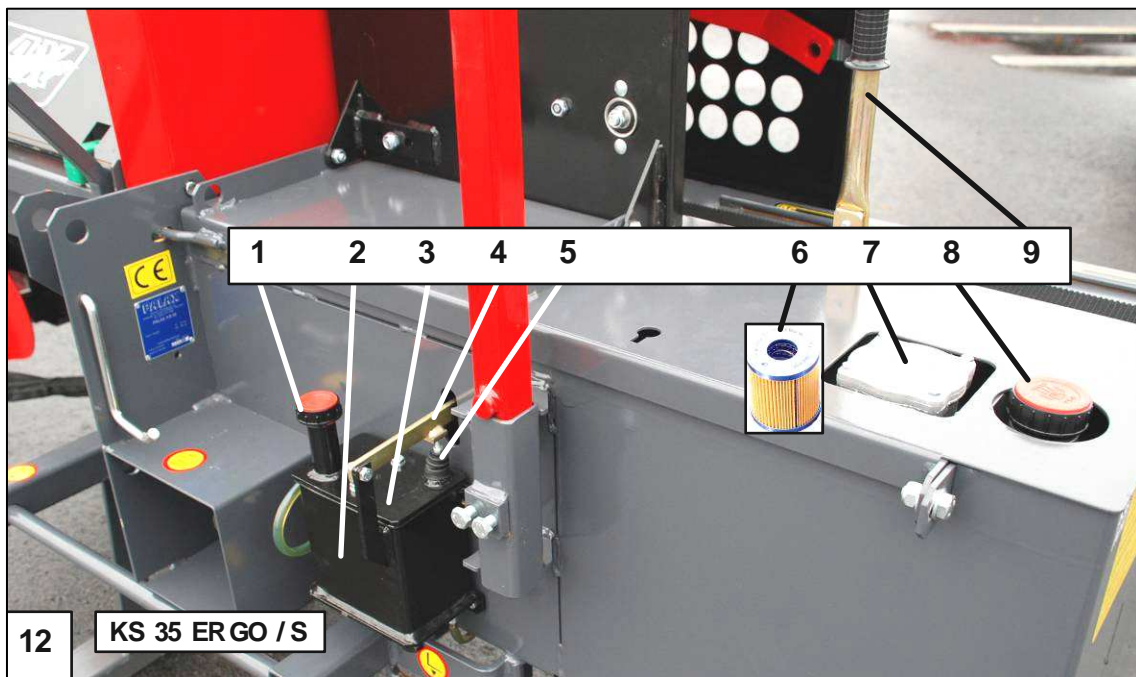
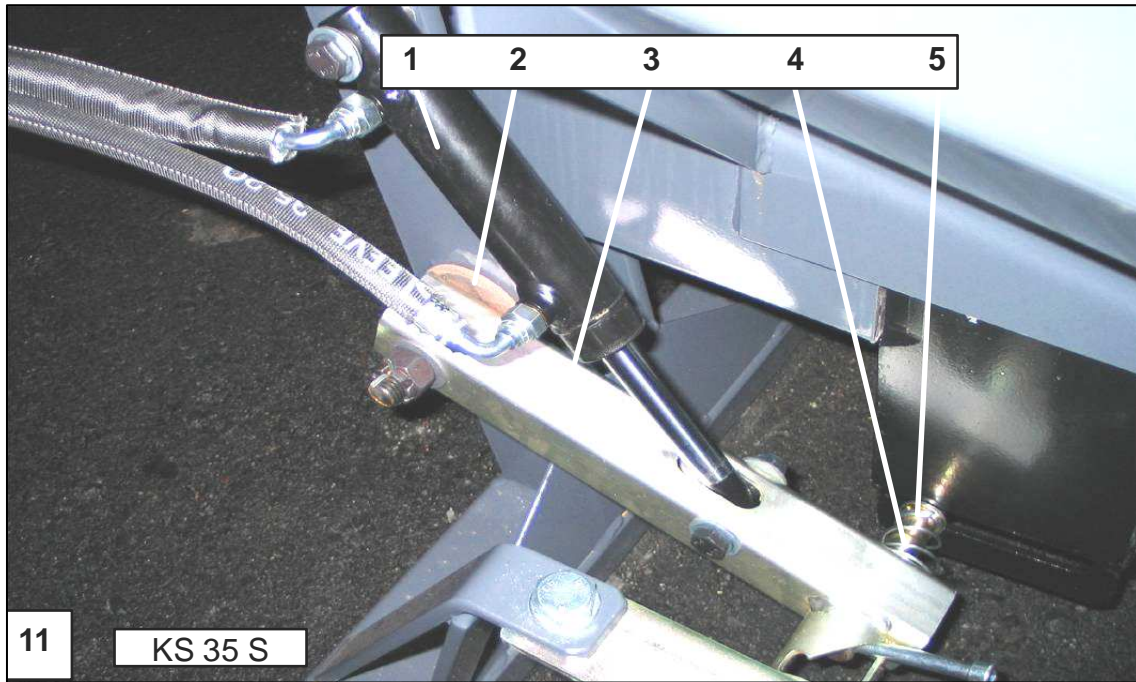

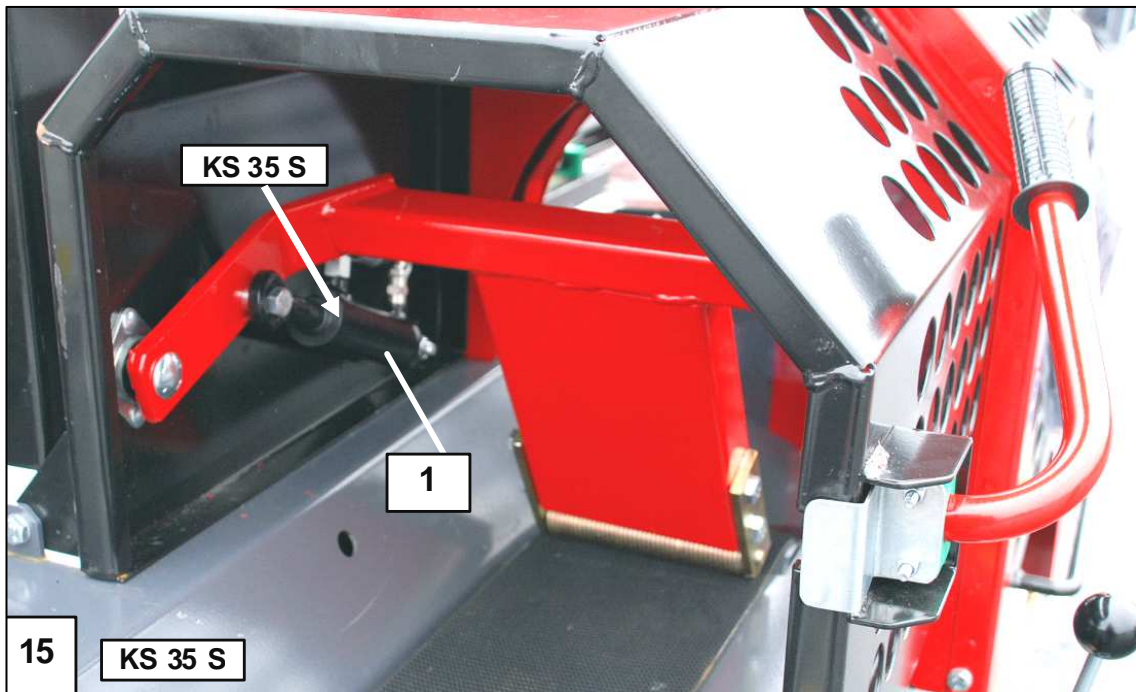
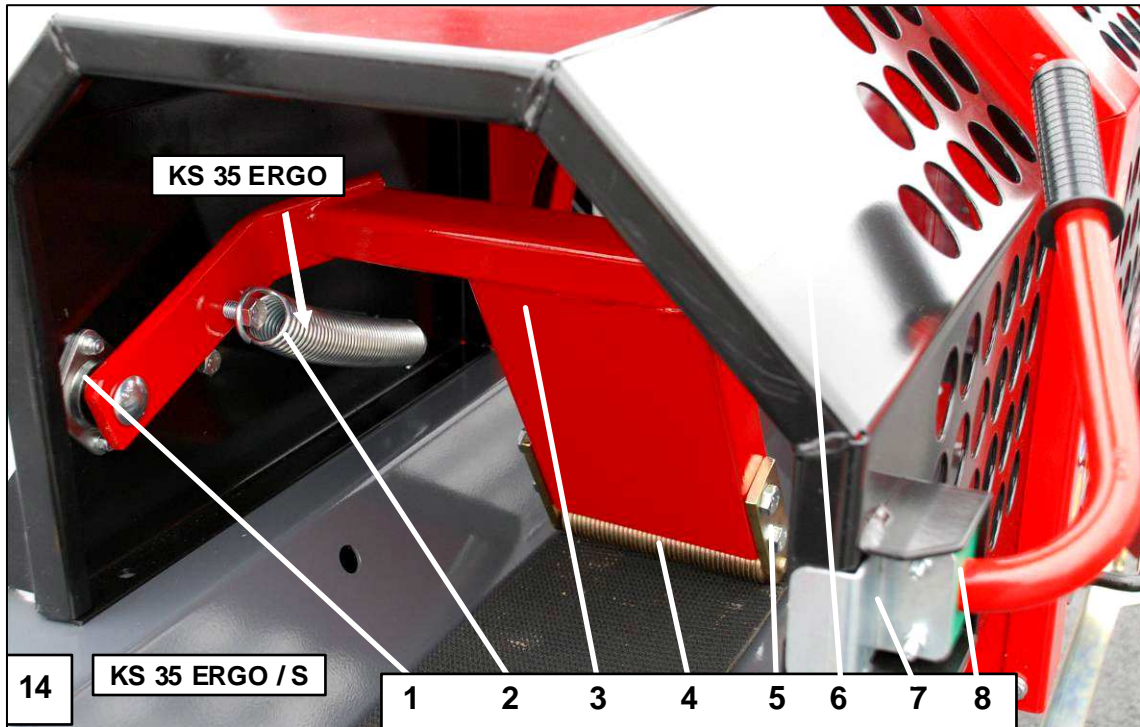

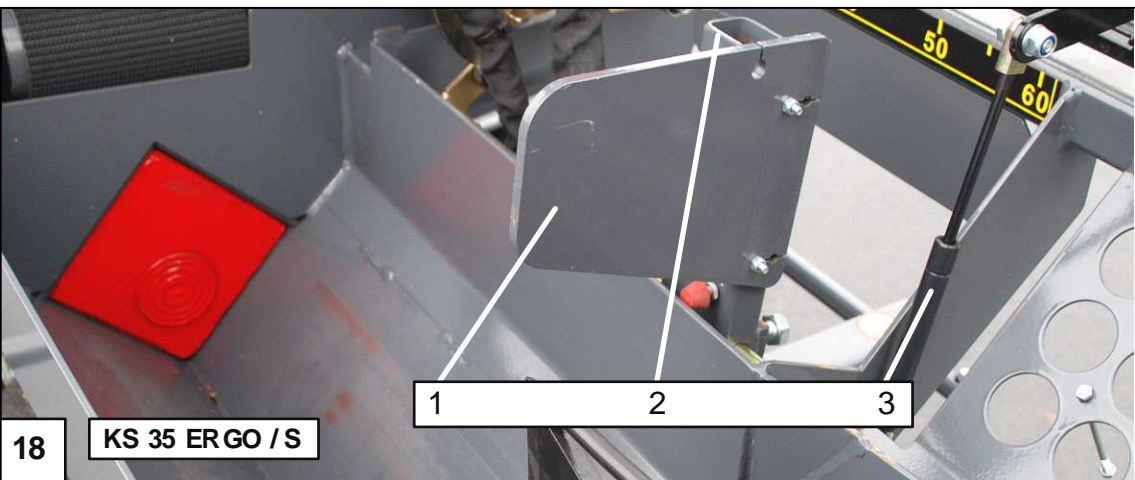
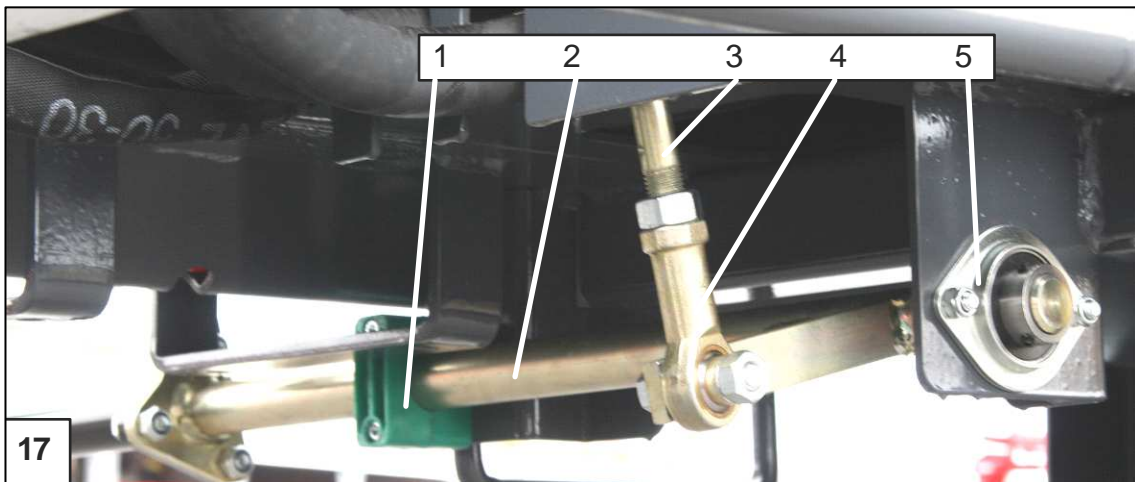
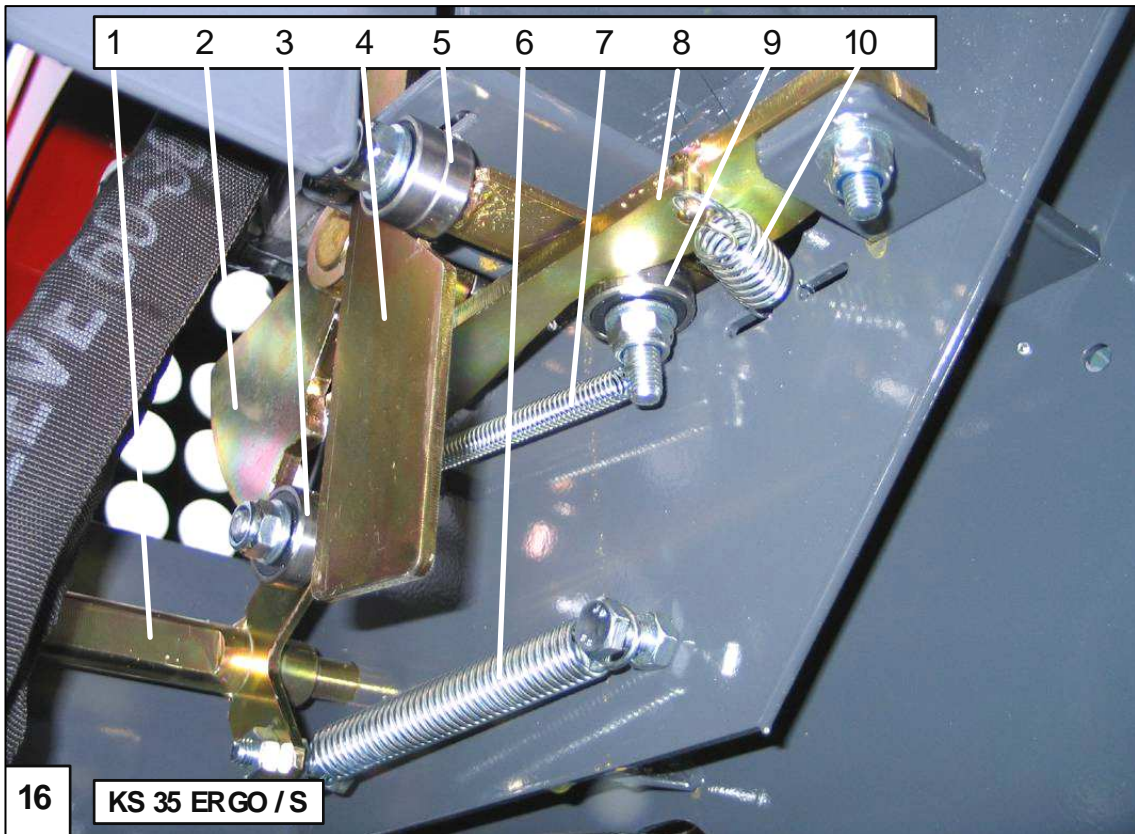

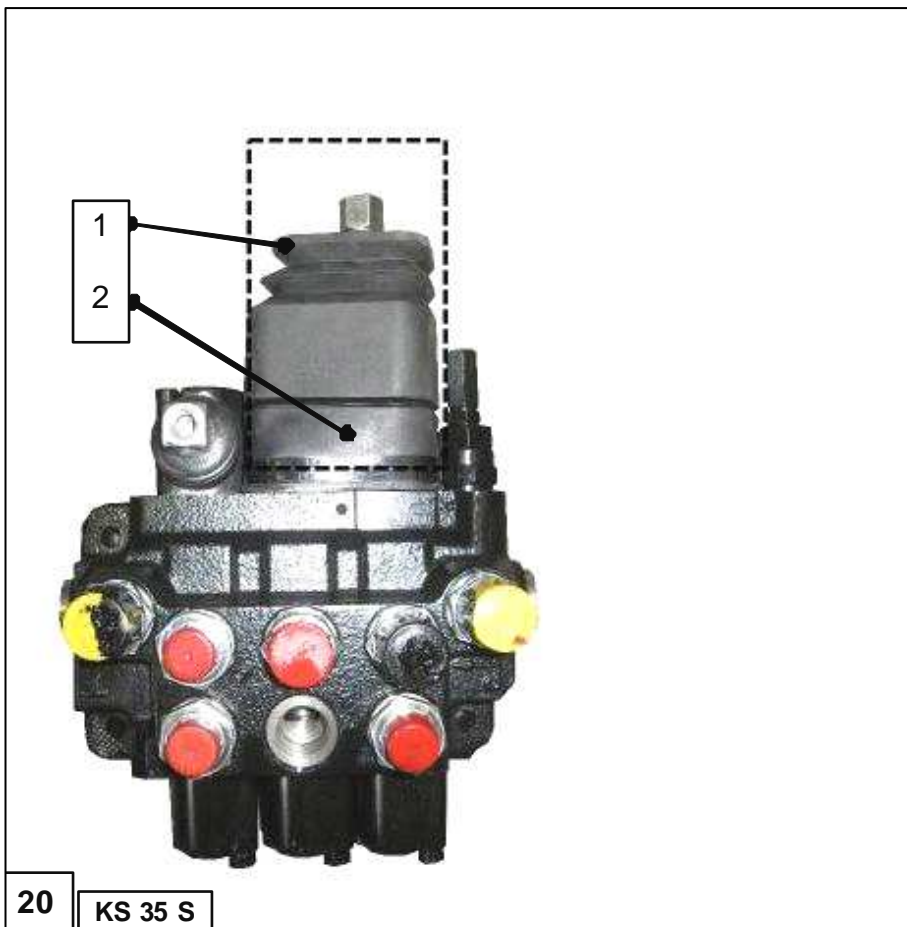
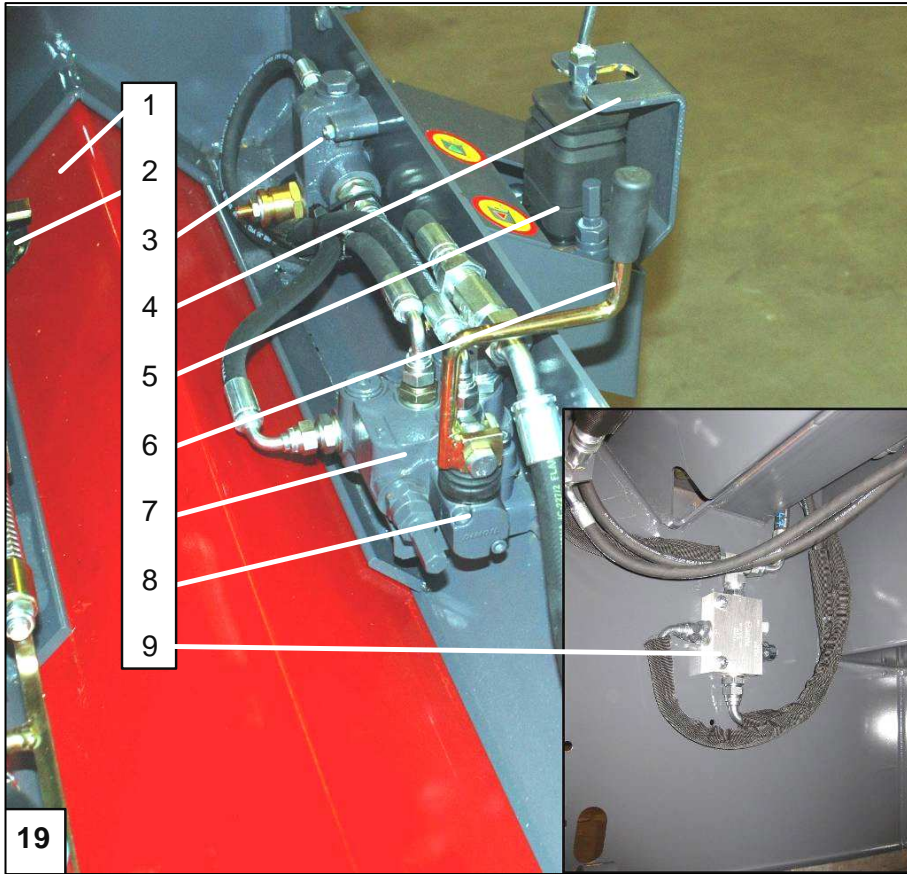

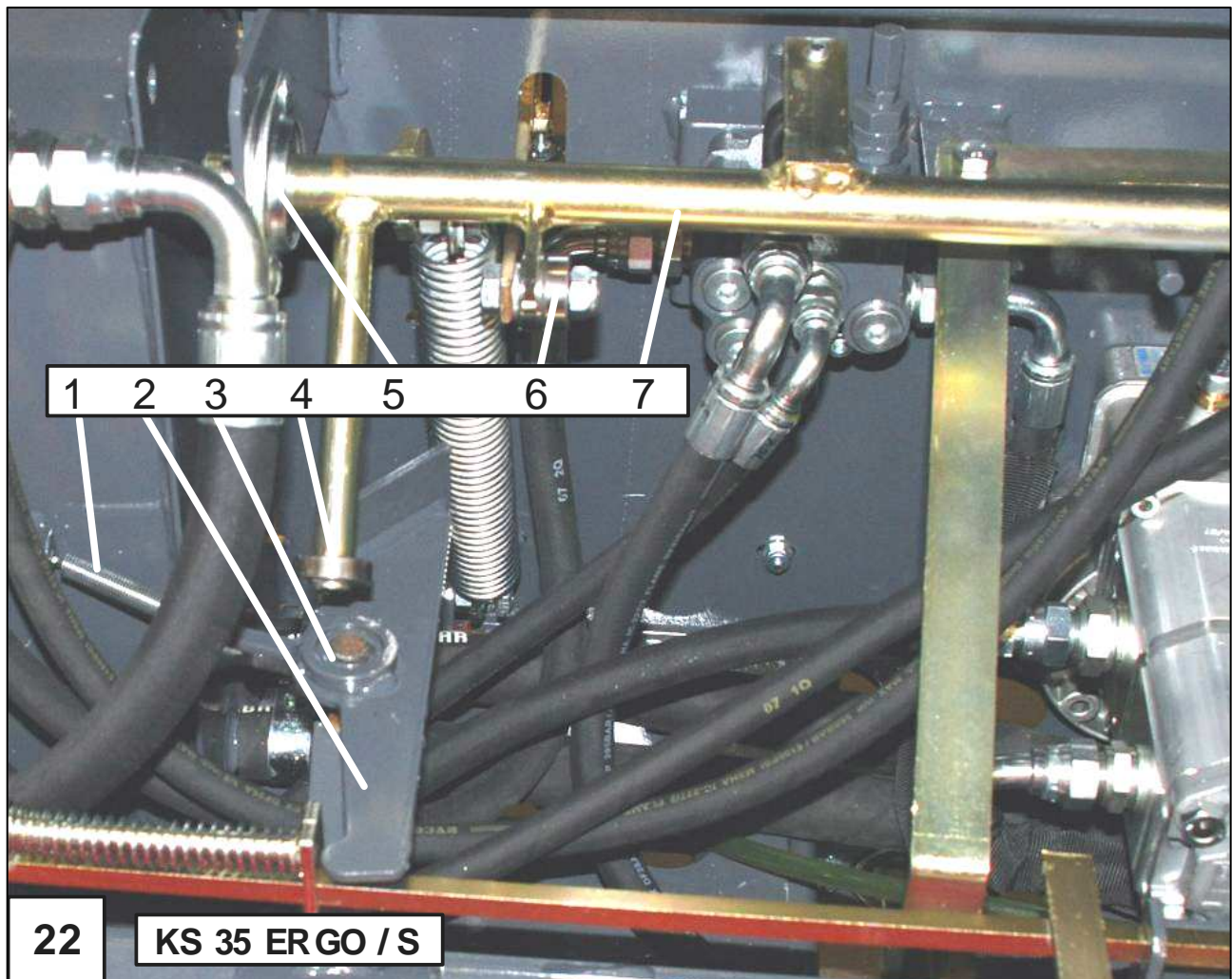
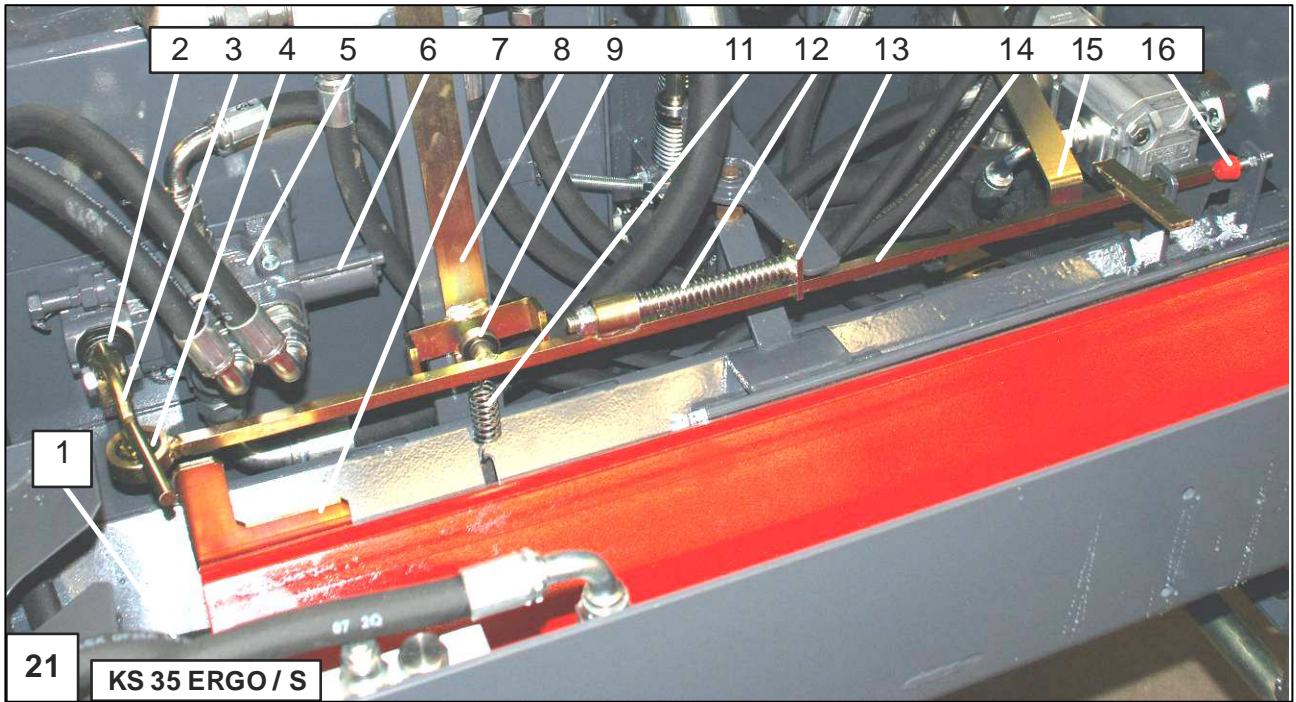

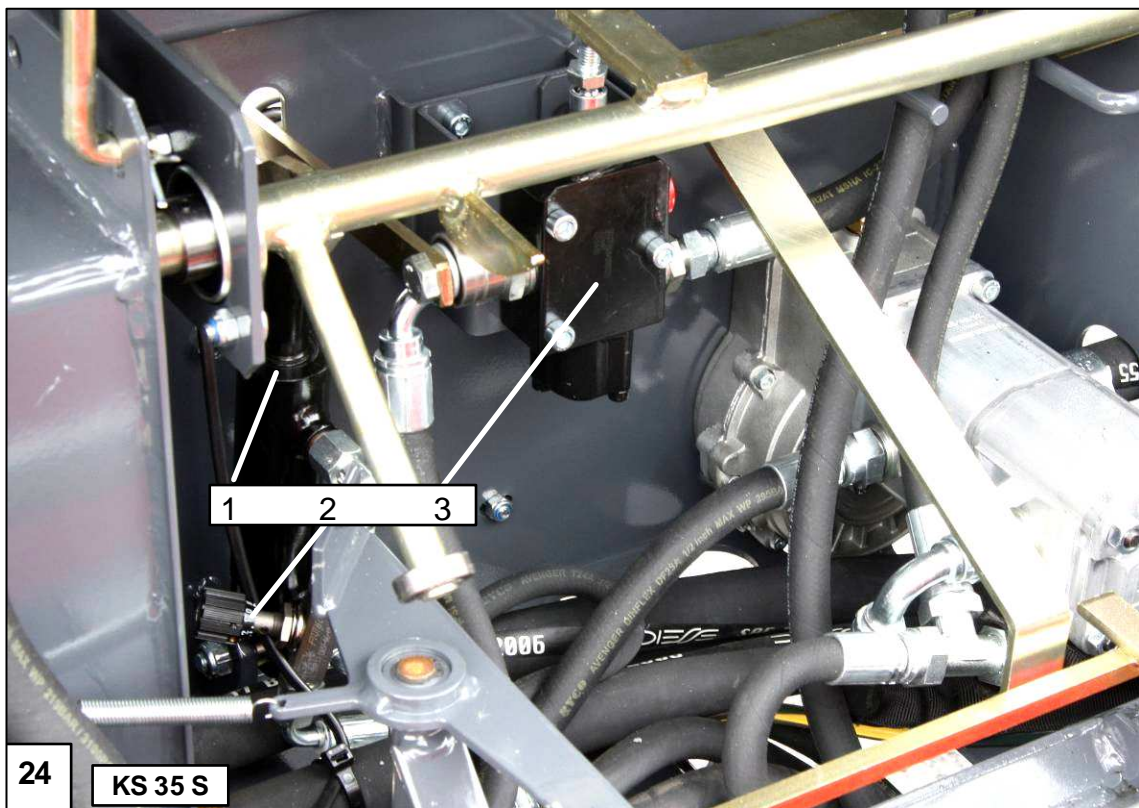
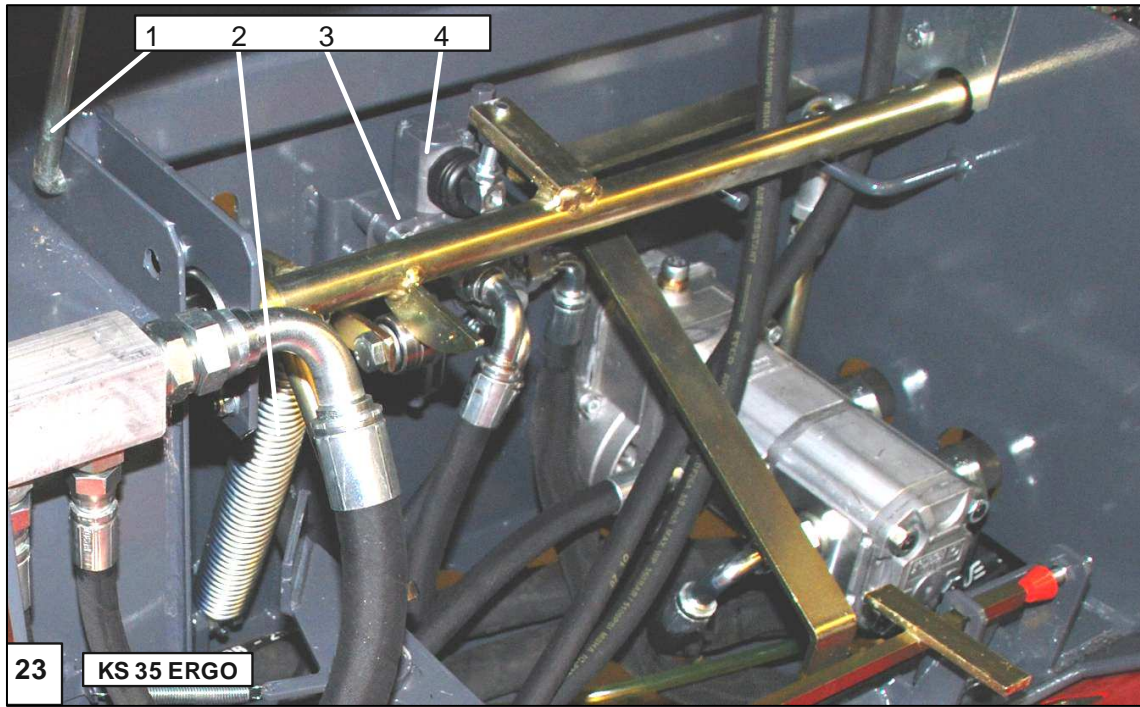

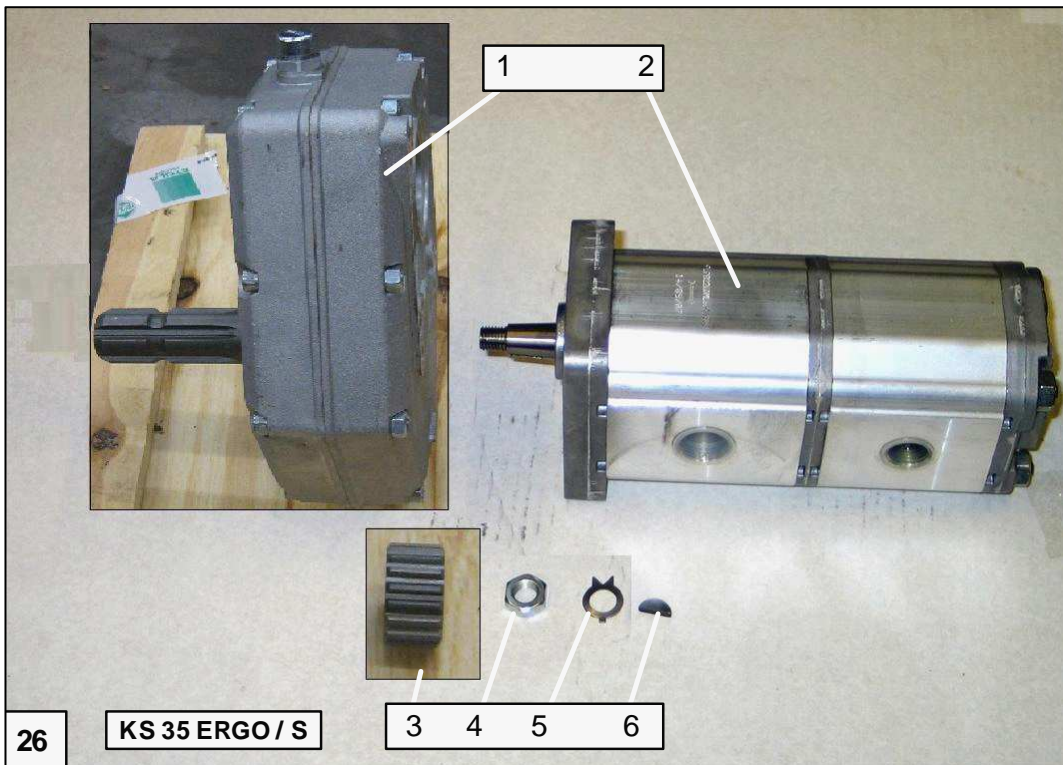
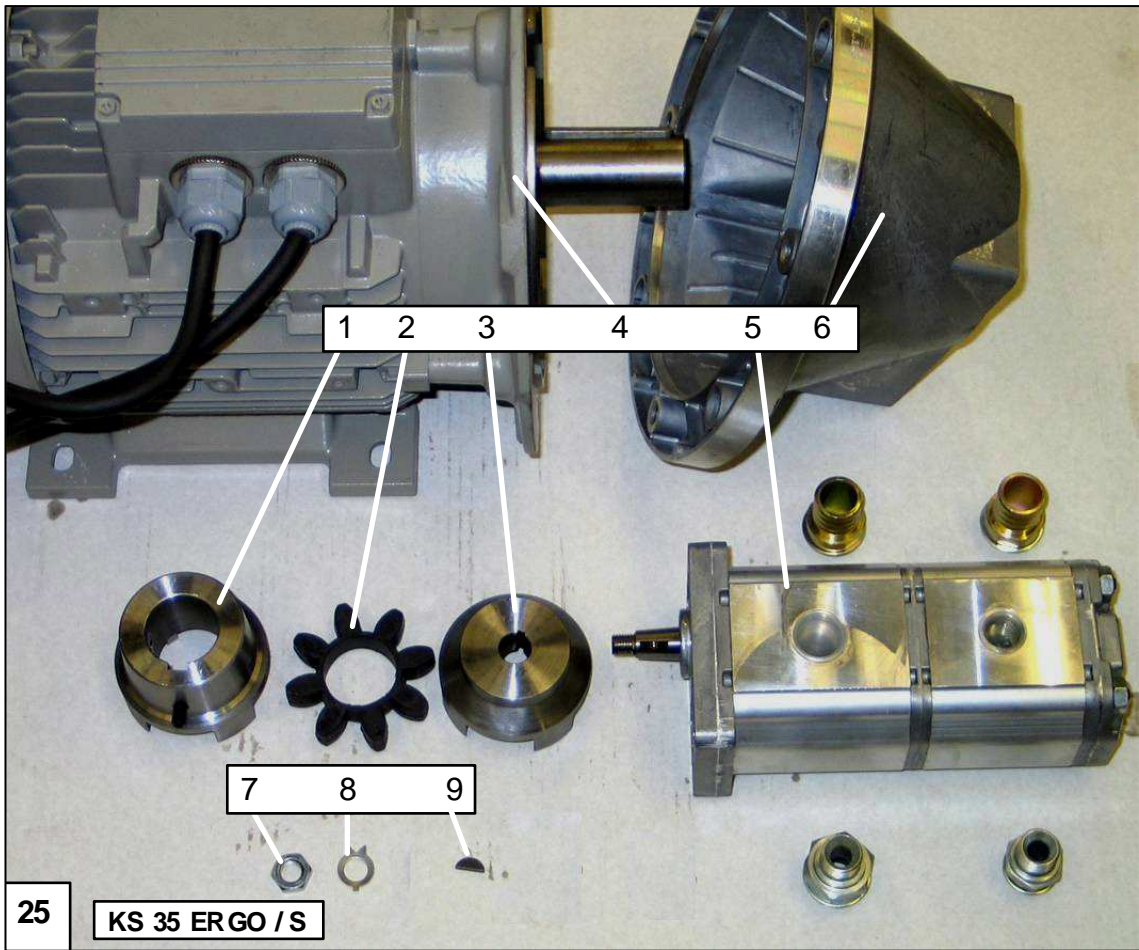

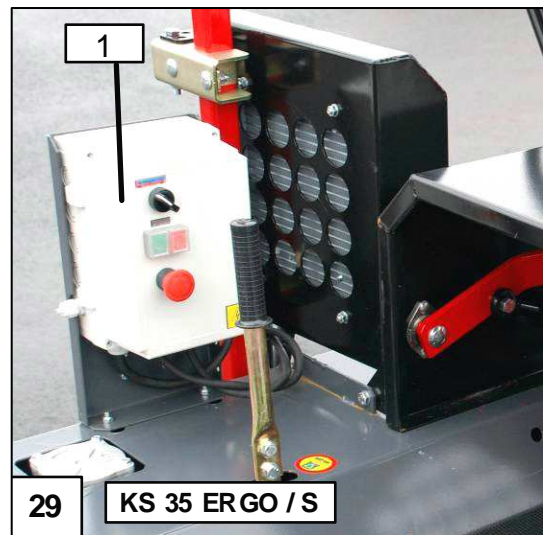
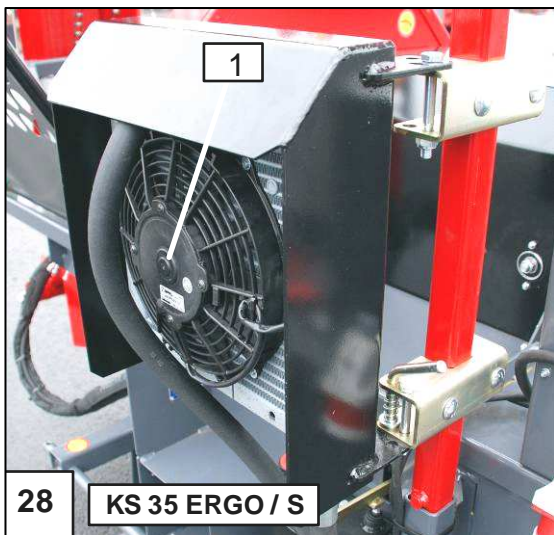
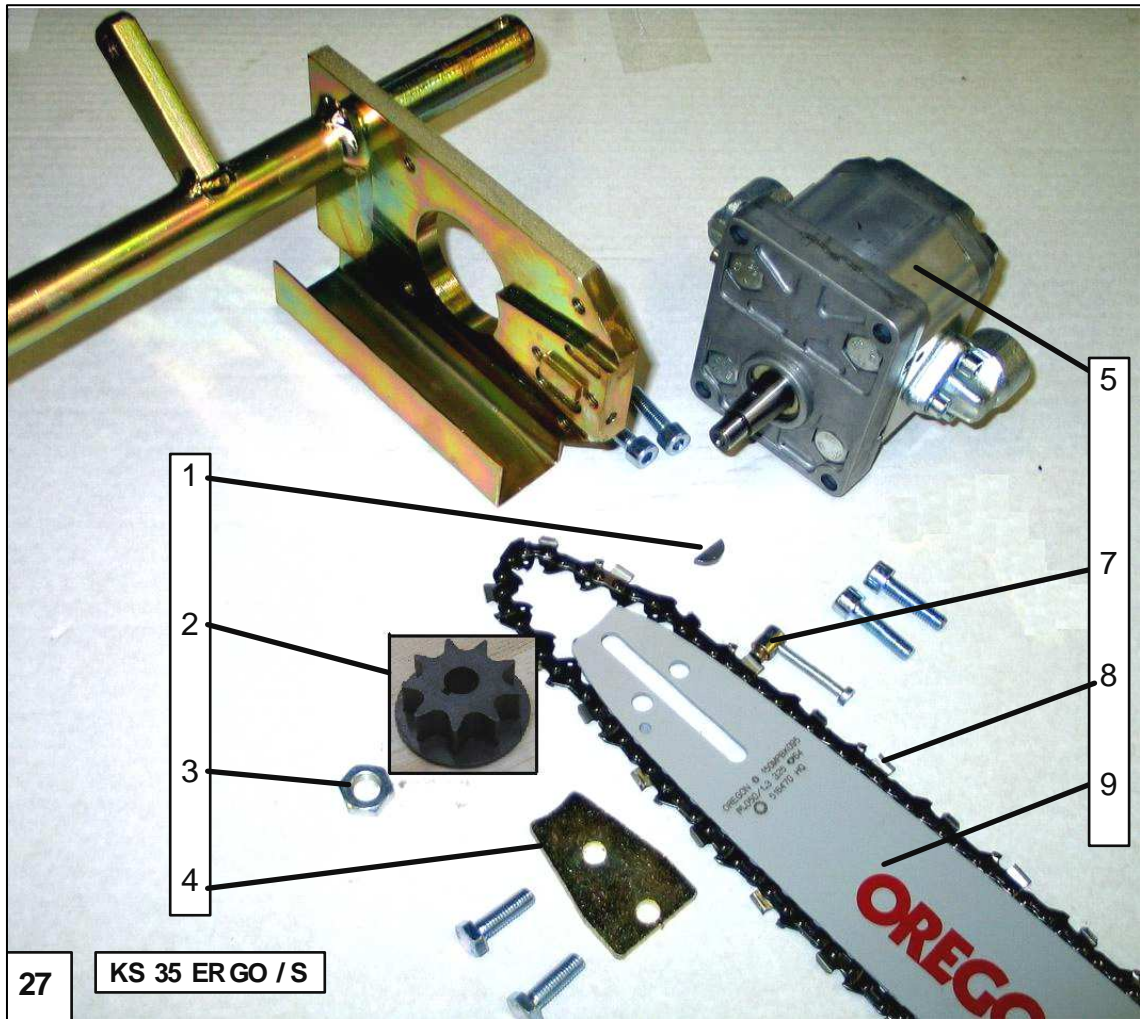

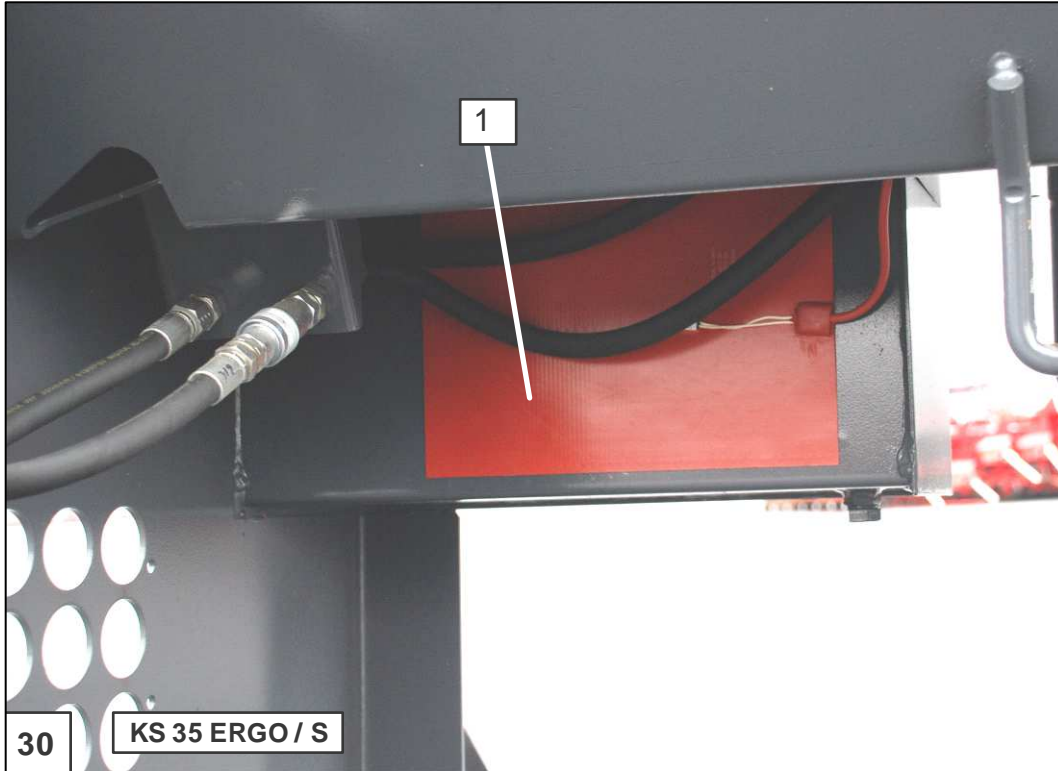

SUOMI

FI

Kuva	Osa	Tilausnumero	Nimitys	Mitat	Kpl
1	1	10 993	Liukupala		2
1	2	31725	Kuljetintuki		1
1	3	31849	Ylärunko		1
1	4	31846	Alarunko		1
1	5	10 008	Vetojousi	1,0x11x65	2
1	6	11 007	Taiton lukko		1
1	7	31732	Sanka	Ø10x1100	1
1	10	32150	Teräkotelo		1
1	11	10 740	Kourun verkko		1
1	12	14 369	Lukko		1
1	13	10 995	Kiinnitysketju		2
1	14	10633	Laakeri	BPFL5	1
2	1	10 993	Liukupala		2
2	2	11 197	Vinssi		1
2	3	10 482	Vaijeri		1
2	4	14392	Vaijeripyörä		2
2	5	10 082	Laakeri	6001 2RS	2
3	1	31730	Kuljettimen ketju		1
3	2	31731	Kola	30x40x200	10
3	3	11 000	Ketju	8760	2
3	4	11 198	Kolan kiinnitysosa	S32W	1
3	5	11 199	Liitososa	S32W	1
4	1	11 200	Taittopyörä		2
4	2	10 596	Laakeri	6205 2RS	2
4	3	11 003	Taittopyörän pidin		2
4	4	11 004	Puristusjousi	5,5x30x340	2
5	1	10 554	Geroottori		1
5	2	14 989	Painerajoitin		1
5	3	32545	Vetoakseli		1
5	4	32151	Laakeri	SBFL207	1
5	5	32152	Pidin		1
5	6	32153	Suoja		1
5	7	32543	Holkki		1
5	8	32544	Kiila		1
6	1	14 322	Suojaverho		1
6	2	14 465	Lukkokantaruuvi	M16x100	1
6	3	31734	Kääntöpalkki		1
6	4	31735	Läppä	05x120x200	1
6	5	31727	Lukituspalkki		1
6	6	31728	Sarana		1

6	7	11 375	Puristusjousi	1,5x25x65	1
7	1	10 592	Kölrulla		1
7	2	10 543	Syöttömatto	200x4550	1
7	3	10 596	Laakeri	6205 2RS	2
7	4	10 595	Jatkopöydänrulla		1
7	5	10 597	Rullanakseli		1
7	6	31 284	Höylä		1
7	7	10 583	Jatkopöytä		1
7	8	10 620	Jalka		1
8	1	10 608	Saranatappi		1
8	2	10 604	Lukko		1
8	3	10 607	Jousi	2,0x25x65	1
8	4	10 600	Kuminauha		1
9	1	10 561	Peltilaippalaakeri	Ø20	1
9	2	10553	Vetorulla		1
9	3	31843	Vetorullan kiinnitin		1
9	4	10 554	Geroottori	OMP 250	1
10	1	10 855	Teränsäätökahva		1
10	2	10 128	Jousilaatta		4
10	3	10 017	Kitkalevy	Ø75	1
10	4	31 443	Lukko		1
10	5	31 444	Jousi	20/40x60	1
11	1	10 986	Sylinteri	32/20-100	1
11	2	10 017	Kitkalevy	Ø75	1
11	3	11 130	Teränsäätövipu	HTS	1
11	4	10 868	Lukko		1
11	5	31 444	Jousi	20/40x60	1
12	1	10 842	Täyttökorkki	3/4"	1
12	2	10 803	Öljysäiliö		1
12	3	10 832	Kansi		1
12	4	10 843	Vipu		1
12	5	10 841	Läpivientikumi	Ø22/10	1
12	6	10 917	Suodatinpatruuna	FIO 100/3	1
12	7	31810	Suodatin	FIO 100/3	1
12	8	10 024	Täyttökorkki	1 1/2"	1
12	9	10 736	Kahva		1
13	1	10 826	Mäntä		1
13	2	10 538	Jousi	2,5x20x45	1
13	3	10 817	Pumpun runko		1
13	4	10 820	Kuula	Ø8	1
13	5	10 821	Jousi	0,6x7,4x20	1
13	6	10 643	Letkulähtö	1/8"	1
14	1	31 672	Peltilaippalaakeri	Ø12	1
14	2	10 062	Jousi	4,5x38x254	1
14	3	31719	Painin		1
14	4	10034	Rulla		1

14	5	31 682	Rullan pidin		1
14	6	31 684	Suojakotelo		1
14	7	31 680	Suojalevy		1
14	8	10 579	Pidin	Ø26,9	4
15	1	32171	Sylinteri	25/16-100	1
16	1	10 780	Pysäytin akseli		1
16	2	10 665	Ohjain		1
16	3	10 081	Laakeri	6301 2RS	1
16	4	10751	Kiila		1
16	5	10 060	Laakeri	6201 2RS	2
16	6	11 202	Jousi	2,5x20x130	1
16	7	10 008	Jousi	1,0x11x68	1
16	8	10 770	Lukko		1
16	9	10 081	Laakeri	6301 2RS	1
16	10	10 735	Jousi	2,0x20x50	1
17	1	10 579	Pidin	Ø26,9	2
17	2	31 679	Akseli		1
17	3	31 685	Tanko		1
17	4	11 446	Nivelpää	JAF16	2
17	5	15 596	Laakeri	SBFL205	1
18	1	31 318	Pysäytin levy		1
18	2	10 794	Pysäytin		1
18	3	31 673	Kaasujousi	KS0127	1
19	1	10 502	Puskin		1
19	2	10 510	Sylinterin tappi		1
19	3	10 988	Virtauksensäädin	Ergo HTS	1
19	4	32449	joystick- kotelo		1
19	5	15 321	joystick-venttiili (S)	(101-2569)	1
19	5	32111	joystick-venttiili (S)	(2570-3849)	1
19	5	32039	joystick-venttiili (S)	(3850-)	1
19	6	31 298	Vipu	Ergo HTS	1
19	7	13 601	Venttiili	Ergo HTS	1
19	8	13 681	Karan siirtäjä	Ergo HTS	1
19	9	10950	Venttiili	APV (101-2569)	1
19	9	10096	Venttiili	APV (2570-)	1
20	1	13 664	Joystick- suoja		1
20	2	13 666	Joystick- korjaussarja		1
21	1	10 073	Sylinteri 50/36-680	3,5t	1
21	1	11 190	Tiivistesarja 50/36	3,5t	1
21	1	10 071	Sylinteri 63/45-680	5,6t	1
21	1	11 191	Tiivistesarja 63/45	5,6t	1
21	2	11 194	Karan siirtäjä		1
21	3	10 686	Venttiilin vipu		1
21	4	10 060	Laakeri	6201 2RS	1
21	5	10095	Venttiili	Halkaisu	1
21	6	11 192	Lukitusosa	Halkaisu	1

21	7	31 319	Ohjain		1
21	8	10 729	Käsivipu		1
21	9	10 082	Laakeri	6001 2RS	1
21	11	10 735	Jousi	2,0x20x50	1
21	12	10 716	Jousi	2,5x20x130	1
21	13	10 711	Työntäjä		1
21	14	14 321	Laukaisutanko		1
21	15	10 755	Palautusvipu		1
21	16	10 540	Puristuskara	M8x35	1
22	1	10 008	Jousi	1,0x11x68	1
22	2	10 719	Heiluri		1
22	3	10 636	Laakeri	6002 2RS	1
22	4	10 636	Laakeri	6002 2RS	1
22	5	15 596	Laakeri	SBFL205	1
22	6	10 060	Laakeri	6201 2RS	2
22	7	32 239	Teräakseli		1
23	1	10 544	Pöydän tuki		1
23	2	10 062	Jousi	4,5x38x254	1
23	3	14 549	Venttiili		1
23	4	13 681	Karan siirtäjä		1
24	1	13 657	Sylinteri ->4246	32/20-100	1
24	1	32247	Sylinteri 4247 ->	Kierre päässä	1
24	2	14 529	Venttiili	1/8"	1
24	3	15 324	Venttiili		1
25	1	13 624	Kytkin, SM	Ø38	1
25	2	10 047	Kumikytkin		1
25	3	13 619	Kytkin, pumppu	GP2	1
25	4	10 170	Sähkömoottori	7,5 kW	1
25	5	10 943	Kaksoispumppu	26+20	1
25	6	10 896	Kiinnityslaippa	7,5/GP2	1
25	7	13 684	Mutteri	M12	1
25	8	13 688	Prikka	GP2	1
25	9	13 683	Kiila	4x6,5	1
26	1	10913	Kertojavaihde	(101-3062)	1
26	1	32156	Kertojavaihde	1/3,8 (3063-)	1
26	2	32173	Kaksoispumppu	22+20 (2570-3061)	1
26	2	10 943	Kaksoispumppu	26+20 (101-2569. 3062-)	1
26	3	13685	Booriholkki	(101-3062)	1
26	3	32157	Booriholkki	(3063-)	1
26	4	13 684	Mutteri	M12	1
26	5	13 688	Prikka	GP2	1
26	6	13 683	Kiila	4x6,5	1
27	1	13 683	Kiila, (101-2569)	4x6,5	1
27	1		Kiila, (2570-)		1
27	2	10 649	Vetoratas	-2570	1

27	2	32160	Vetoratas	2571-	1
27	3	13 684	Mutteri, (101-2569)	M10 matala	1
27	3		Mutteri, (2570-)		1
27	4	31 288	Laippa		1
27	5	10644	Moottori, iso	(101-2569)	1
27	5	32096	Moottori, pieni	3,6cm3 (2570-)	1
27	6	31 678	Letkunsuoja		1
27	7	10 650	Tappi		1
27	8	10 653	Teräketju	64 .325" 1,3	1
27	9	10 652	Terälaippa	15" .325" 1,3	1
28	1	31 674	Öljyn jäähdyttäjä		1
29	1	10 904	Käynnistin	7,5 kW	1
30	1	15028	Lämmitysmatto		1
31	1	15 587	Termostaatti	NTB47CA1/2	1

ENGLISH

Figure	Part	Ordering no.	Designation	Dimensions	Pc.
1	1	10 993	Gide block		2
1	2	10 879	Conveyor support		1
1	3	31849	Upper frame		1
1	4	31846	Lower frame		1
1	5	10 008	Draw-spring	1,0x11x65	2
1	6	11 007	Swing lock		1
1	7	31732	Bow	Ø10x1100	1
1	10	32150	Blade cover		1
1	11	10 740	Chute net		1
1	12	14 369	Lock		1
1	13	10 995	Attachment chain		2
1	14	10633	Bearing	BPFL5	1
2	1	10 993	Gide block		2
2	2	11 197	Winch		1
2	3	10 482	Wire		1
2	4	14392	Bearing		2
2	5	10 082	Wire wheel	6001 2RS	2
3	1	31730	Conveyor chain		1
3	2	31731	Scraper	30x40x200	10
3	3	11 000	Chain	8760	2
3	4	11 198	Attachment part	S32W	1
3	5	11 199	Extension	S32W	1
4	1	11 200	Return roller		2
4	2	10 596	Bearing	6205 2RS	2
4	3	11 003	Return roller bracket		2
4	4	11 004	Pressure-spring	5,5x30x340	2
5	1	10 554	Gerotor		1
5	2	14 989	Pressure relief valve		1
5	3	32545	Drive shaft		1
5	4	32151	Wire wheel	SBFL207	1
5	5	32152	Holder		1
5	6	32153			1
5	7	32543	Bushing		1
5	8	32544	Wedge		1
6	1	14 322	Curtain		1
6	2	14 465	Lock cap bolt	M16x100	1
6	3	31734	Swing beam		1

6	4	31735	Flap	05x120x200	1
6	5	31727	Locking lever		1
6	6	31728	Hinge		1
6	7	11 375	Spring	1,5x25x65	1
7	1	10 592	Keel roller		1
7	2	10 543	In-feed belt	200x4553	1
7	3	10 596	Bearing	6205 2RS	2
7	4	10 595	Table extension roller		1
7	5	10 597	Roller shaft		1
7	6	31 284	Scraper		1
7	7	10 583	Table extension		1
7	8	10 620	Leg		1
8	1	10 608	Hinge pin		1
8	2	10 604	Lock		1
8	3	31725	Spring	2,0x25x65	1
8	4	10 600	Rubber band		1
9	1	10 561	Plate flange bearing	Ø20	1
9	2	10553	Drive roller		1
9	3	31843	Fasteninf, rewind roller		1
9	4	10 554	Gerotor	OMP 250	1
10	1	10 855	Wedge adjustment handle		1
10	2	10 128	Spring washer		4
10	3	10 017	Friction plate	Ø75	1
10	4	31 443	Lock		1
10	5	31 444	Spring	20/40x60	1
11	1	10 986	Cylinder	32/20-100	1
11	2	10 017	Friction plate	Ø75	1
11	3	11 130	Shift lever	HTS	1
11	4	10 868	Lock		1
11	5	31 444	Spring	20/40x60	1
12	1	10 842	Fill cap	3/4"	1
12	2	10 803	Oil tank		1
12	3	10 832	Cover		1
12	4	10 843	Lever		1
12	5	10 841	Lead-through	Ø22/10	1
12	6	10 917	Filter cartridge	FIO 100/3	1
12	7	31810	Filter	FIO 100/3	1
12	8	10 024	Fill cap	11/2"	1
12	9	10 736	Handle		1
13	1	10 826	Piston		1
13	2	10 538	Spring	2,5x20x45	1
13	3	10 817	Pump housing		1
13	4	10 820	Ball	Ø8	1
13	5	10 821	Spring	0,6x7,4x20	1
13	6	10 643	Hose outlet	1/8"	1
14	1	31 672	Plate flange bearing	Ø20	1

14	2	10 062	Spring	4,5x38x254	1
14	3	31719	Clamp		1
14	4	10034	Roller		1
14	5	31 682	Roller bracket		1
14	6	31 684	Protective cover		1
14	7	31 680	Cover plate		1
14	8	10 579	Holder	Ø26,9	4
15	1	32171	Cylinder	25/16-100	1
16	1	10 780	Stopper shaft		1
16	2	10 665	Guide		1
16	3	10 081	Bearing	6301 2RS	1
16	4	10751	Wedge		1
16	5	10 060	Bearing	6201 2RS	2
16	6	11 202	Spring	2,5x20x130	1
16	7	10 008	Spring	1,0x11x68	1
16	8	10 770	Lock		1
16	9	10 081	Bearing	6301 2RS	1
16	10	10 735	Spring	2,0x20x50	1
17	1	10 579	Holder	Ø26,9	2
17	2	31 679	Shaft		1
17	3	31 685	Rod		1
17	4	11 446	Swivel head	JAF16	1
17	5	15 596	Lager	SBFL205	1
18	1	31 318	Stop plate		1
18	2	10 794	Stopper		1
18	3	31 673	Gas spring	KS0127	1
19	1	10 502	Ram		1
19	2	10 510	Cylinder pin		1
19	3	10 988	Flow regulator	HTS	1
19	4	32449	casing, Joystick		1
19	5	15 321	Joystick (S)	(101-2569)	1
19	5	32111	Joystick (S)	(2570-3849)	1
19	5	32039	Joystick (S)	(3850-)	1
19	6	31 298	Lever	HTS	1
19	7	13 601	Valve	HTS	1
19	8	13 681	Spool shifter	HTS	1
19	9	10950	Valve	APV (101-2569)	1
19	9	10096	Valve	APV (2570-)	1
20	1	13 664	Joystick cover		1
20	2	13 666	repair kit, joystick		1
21	1	10 073	Cylinder 50/36-680	3,5t	1
21	1	11 190	Seal kit 50/36	3,5t	1
21	1	10 071	Cylinder 63/45-680	5,6t	1
21	1	11 191	Seal kit 63/45	5,6t	1
21	2	11 194	Spool shifter		1
21	3	10 686	Valve lever		1

21	4	10 060	Bearing	6201 2RS	1
21	5	10095	Valve		1
21	6	11 192	Lock-up part		1
21	7	31 319	Guide		1
21	8	10 729	Hand lever		1
21	9	10 082	Bearing	6001 2RS	1
21	11	10 735	Spring	2,0x20x50	1
21	12	10 716	Spring	2,5x20x130	1
21	13	10 711	Pusher		1
21	14	14 321	Launch bar		1
21	15	10 755	Return lever		1
21	16	10 540	Press pin	M8x35	1
22	1	10 008	Spring	1,0x11x68	1
22	2	10 719	Pendulum		1
22	3	10 636	Bearing	6002 2RS	1
22	4	10 636	Bearing	6002 2RS	1
22	5	15 596	Bearing	SBFL205	1
22	6	10 060	Bearing	6201 2RS	2
22	7	32 239	Blade shaft		1
23	1	10 544	Table support		1
23	2	10 062	Spring	4,5x38x254	1
23	3	14 549	Valve		1
23	4	13 681	Spool shifter		1
24	1	13 657	Cylinder ->4246	32/20-100	1
24	1	32247	Cylinder 4247->	Spiral in top	1
24	2	14 529	Valve	1/8"	1
24	3	15 324	Valve		1
25	1	13 624	Coupling, SM	Ø38	1
25	2	10 047	Rubber coupling		1
25	3	13 619	Coupling, pump	GP2	1
25	4	10 170	Electric motor	7,5 kW	1
25	5	10 943	Double pump	26+20	1
25	6	10 896	Attachment flange	7,5/GP2	1
25	7	13 684	Nut	M12	1
25	8	13 688	Washer	GP2	1
25	9	13 683	Wedge	4x6,5	1
26	1	10913	Speed multiplier gear	(101-3062)	1
26	1	32156	Speed multiplier gear	1/3,8 (3063-)	1
26	2	32173	Double pump	22+20 (2570-3061)	1
26	2	10 943	Double pump	26+20(101-2569,3062-)	1
26	3	13685	Bushing	(101-3062)	1
26	3	32157	Bushing	(3063-)	1
26	4	13 684	Nut	M12	1
26	5	13 688	Washer	GP2	1
26	6	13 683	Wedge	4x6,5	1
27	1	13 683	Wedge	4x6,5	1

27	2	10 649	Drive roller	-2570	1
27	2	32160	Drive roller	2571-	1
27	3	13 684	Nut	M10	1
27	4	31 288	Flange		1
27	5	10644	Motor	(101-2569)	1
27	5	32096	Motor	3,6cm3(2570-)	1
27	6	31 678	Hose jacket		1
27	7	10 650	Pin		1
27	8	10 653	Saw-chain	64 .325" 1,3	1
27	9	10 652	Sawbar	15" .325" 1,3	1
28	1	31 674	Oil cooler		1
29	1	10 904	Starter	7,5 kW	1
30	1	15028	Heater carpet		1
31	1	15 587	Thermostat	NTB47CA1/2	1