

Instruction manual

Palax Power 70

Palax Power 70 s

- Powered by a tractor
- Powered by an electric motor



Serial number _____

Year of manufacture _____

PALAX
Lahdentie 9
FI-61400 Ylistaro, FINLAND
Tel. +358 6 4745100
Fax. +358 6 4740790
www.palax.fi

1	BASIC SPECIFICATIONS AND RESPONSIBILITIES.....	4
1.1	FOREWORD.....	4
1.2	EU DECLARATION OF CONFORMITY	5
1.3	INTENDED USE OF THE MACHINE	6
1.4	WARNING SIGNS.....	6
1.5	NAMEPLATES	7
1.6	THE MAIN DIMENSIONS AND MODELS OF THE MACHINE.....	8
1.7	SAFETY INSTRUCTIONS.....	8
1.8	NOISE EMISSION AND VIBRATION	9
1.9	RESPONSIBILITIES OF THE OPERATOR	9
1.10	OPERATING CONDITIONS	10
1.11	TERMS OF WARRANTY	10
1.12	OPERATING INSTRUCTIONS FOR THE WINCH	10
2	TAKING DELIVERY AND SETTING UP THE MACHINE FOR OPERATION.....	11
2.1	LIFTING THE MACHINE	11
2.2	THE TRANSPORT SET-UP AND UNPACKING.....	11
2.3	ACCEPTANCE INSPECTION	11
2.4	MAIN PARTS OF THE MACHINE, FIG 1	11
2.5	OPERATING CONTROLS OF THE MACHINE, FIG. 2	12
2.6	TABLE EXTENSION, FIG. 3	12
2.7	BRINGING THE CONVEYOR INTO THE WORK POSITION, FIGS. 4, 5, 6 AND 7	13
2.8	BRINGING THE CONVEYOR INTO THE TRANSPORT POSITION, FIG. 4, 5, 6 AND 7	13
3	OPERATION OF THE FIREWOOD PROCESSOR POWERED BY DIFFERENT POWER SOURCES	14
3.1	POWERED BY A TRACTOR	14
3.2	EMERGENCY STOP SWITCH OF THE TRACTOR POWERED MACHINE, FIG. 9.....	14
3.3	REQUIRED MEASURES IN AN EMERGENCY SITUATION.....	15
3.4	STARTING UNDER COLD CONDITIONS	15
3.5	ELECTRIC DRIVE, START AND EMERGENCY STOP, FIG. 10.....	15
3.6	STARTING THE ELECTRIC MOTOR	16
3.7	EMERGENCY STOP OF A MACHINE POWERED BY ELECTRIC MOTOR, FIGURE 10	16
3.8	THE MACHINE IS EQUIPPED WITH A SYSTEM TO PREVENT SIMULTANEOUS OPERATION IN TWO MODES, FIG. 11... ..	16
3.9	OPERATION UNDER COLD CONDITIONS	17
4	FULLY HYDRAULIC CONTROL OF THE POWER 70 S FIREWOOD PROCESSOR, FIG 13.....	18
4.1	MASTERING THE SAFETY DEVICES.....	18
4.2	JOYSTICK-VALVE, No. 1, FIG. 13.....	18
4.3	OPERATING LEVER FOR THE SPLITTING WEDGE No. 2, FIG. 13	18
4.4	ADJUSTMENT VALVE No.3 FOR PROCEEDING SPEED OF CROSSCUT BLADE, FIG. 12, ONLY IN S-MODEL	18
4.5	JOYSTICK-VALVE, No. 4, FIG. 13.....	19
5	MECHANICAL CONTROL OF THE POWER 70 FIREWOOD PROCESSOR USING THE MULTI-FUNCTION LEVER	19
5.1	MASTERING THE SAFETY DEVICES.....	19
5.2	CONTROL LEVERS FOR POWER 70, FIG. 14A	19
6	USE OF THE FIREWOOD PROCESSOR, CROSSCUT OPERATION.....	20
6.1	OPERATING THE CROSSCUT SAW, BEFORE THE OPERATION	20
6.2	DURING THE OPERATION	20
6.3	CUTTING TO EQUAL LENGTH AND FEEDING INTO THE SPLITTING CHUTE.....	21
6.4	FEEDING THE LAST LOG FOR SPLITTING	21
7	DISTURBANCES DURING CROSSCUT OPERATION AND THEIR REMEDY.....	21
7.1	CROOKED TREES	21
7.2	BIG TREES	21
7.3	CUTTING OF SMALL TREES WITHOUT SPLITTING	22
7.4	DISTURBANCES DURING THE SPLITTING OPERATION AND THEIR REMEDY	22
7.5	RE-SPLITTING THE LOGS SAFELY	22
8	ACCESSORIES FOR THE FIREWOOD PROCESSOR.....	22

8.1	SPLITTING CYLINDER	22
8.2	MANUALLY-OPERATED HIGH-SPEED VALVE, FIGURE 16	22
8.3	AUTOMATIC HIGH-SPEED VALVE	23
8.4	SPLITTING WEDGES	23
9	MAINTENANCE OF THE MACHINE.....	23
9.1	REMOVAL AND CHANGE OF THE CROSSCUT BLADE, FIG 17 AND 18	23
9.2	TIGHTENING THE V-BELTS, CENTRE SHAFT/BLADE SHAFT, FIG. 18.....	24
9.3	REPLACEMENT OF THE V-BELTS, CENTRE SHAFT / SAW-BLADE SHAFT	24
9.4	SHARPENING THE BLADE, HARD-METAL BLADE	24
9.5	SETTING THE SAW-BLADE, HARD-METAL BLADE	24
9.6	SPARE BLADE	25
9.7	TIGHTENING THE V-BELTS, ANGULAR GEAR /CENTRE SHAFT	25
9.8	REPLACEMENT OF V-BELTS, ANGULAR GEAR /CENTRE SHAFT	25
9.9	TIGHTENING THE INFEED CONVEYOR BELT, FIG. 19.....	25
9.10	REPLACEMENT OF THE INFEED CONVEYOR BELT	26
9.11	DIRECTION OF ROTATION OF THE BELT	26
9.12	CHANGING THE OIL IN THE ANGULAR GEAR.....	26
9.13	CHANGING THE HYDRAULIC OIL, FIG. 21	26
9.14	LUBRICATING THE MACHINE: REFER TO THE MAINTENANCE SCHEDULE	26
9.15	SERVICING THE MAIN VALVE, FIG. 24.....	27
9.16	DETENT END OF THE VALVE, FIG. 24 A.....	27
9.17	LUBRICATING THE SPOOL SHIFTER, FIG. 24 B	27
9.18	STRUCTURE OF THE DETENT END AND THE CORRECT ORDER OF THE PARTS, FIG. 26.....	28
9.19	INITIAL SETTINGS OF THE VALVE	28
9.20	TIGHTENING AND LUBRICATION OF THE CONVEYOR CHAIN, FIG. 27	28
9.21	CLEANING THE CONVEYOR	29
9.22	WASHING THE MACHINE.....	29
9.23	STORING THE MACHINE.	29
10	MAINTENANCE SCHEDULE	29
11	MALFUNCTIONS AND THEIR REMEDY	30
12	ELECTRIC DIAGRAMS.....	31

1 Basic specifications and responsibilities

1.1 Foreword

This Instruction Manual is intended for a professional operator of the machine. The operator must have usual general knowledge and skills. For example, the buyer of a tractor-powered machine is expected to master the use of power take-off shaft transmission.

Before the installation and operation, the operator of the machine must become thoroughly familiar with the contents of the manual. The operator is also obliged to gain familiarity with the operating controls of the machine and the emergency stop mechanism. For more information about our products, please visit our website at www.palax.fi.

NOTE ! Keep this manual with the machine at all times.

1.2 EU Declaration of Conformity

Directive 2006/42/EC

Manufacturer: Ylistaron Terästäkomo Oy
www.palax.fi
Lahdentie 9
FI-61400 Ylistaro
Finland
+358 6 474 5100

The person in charge of Technical Construction File: Mikko Koivusalo

Product: Palax Power 70, Palax Power 70 s
a firewood processor with 4,3-m discharge conveyor
Powered by: Tractor P.T.O. or electric motor
Models: TR Powered by tractor equipped with own hydraulic system
TR/SM Powered by tractor or electric motor

Serial number of the machine: _____

We hereby certify that the machine meets the requirements of the Government Decree 12.6.2008/400 on safety of machinery through which the Machine Directive 2006/42/EC has been put into effect, and that during the manufacturing process the following harmonized standards have been applied.

SFS-HANDBOOK 93-series, SFS-EN 349-1+A1, SFS-EN 609-1+A1, SFS-EN 618, SFS-EN 620, SFS-EN 847-1+A1, SFS-EN 847-2+A1, SFS-EN 847-3, SFS-EN 953+A1, SFS-EN 954-1, SFS-EN 982+A1, SFS-EN 1870-3+A1, SFS-EN 4254-1, SFS-EN 11684, SFS-EN 12100-1+A1, SFS-EN 12100-2, SFS-EN 13850, SFS-EN 13857, SFS-EN 14121-1, ISO/TR 14121-2, SFS-EN 60204-1+A1.

Ylistaron Terästäkomo Oy
29.12.2009



Martti Vaurio
Managing Director

1.3 Intended use of the machine

This Firewood Processor with Conveyor is intended to be used for production of firewood from round timber. Use of the machine for any other purposes is prohibited.

Maximum size of the wood







For cutting, the maximum diameter of the tree is about 25 cm.

The maximum length of the log is 4-5 m.

When handling long trees, we recommend using a specific log-lifting deck with rollers or hydraulic feed.

1.4 Warning signs

			 Emergency stop
Read the instruction manual	Use eye guards and hearing protectors	Beware of the moving saw-bar	
 Reversing the infeed conveyor:	 Feeding with the infeed conveyor	 Interrupting the splitting	 Launch of splitting.
 Adjusting the splitting wedge height.	 Sawing	 Slow movement	 Rapid movement
 Permissible			 Direction of rotation of

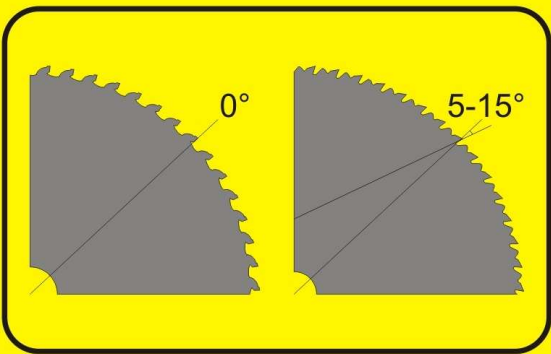
revolutions range of the PTO shaft	Opening the protective net for the splitting chute interrupts the splitting		the motor
 <p data-bbox="150 521 389 595">Lifting point for forklift truck</p>	 <p data-bbox="505 510 699 548">Lifting point</p>	 <p data-bbox="831 539 1102 645">The machine may only be operated by one person</p>	 <p data-bbox="1150 539 1449 613">Stay away from the moving parts</p>
 <p data-bbox="150 969 469 1003">Beware of PTO shaft</p>	 <p data-bbox="505 864 1091 931">The danger zone around the conveyor is 5 metres</p>		 <p data-bbox="1150 969 1474 1115">Disconnect the machine from the power source before servicing</p>
			
<p data-bbox="150 1503 943 1536">Blade without raker teeth: chipping angle 0 degrees</p> <p data-bbox="150 1536 948 1570">Blade with raker teeth: chipping angle 5–15 degrees</p>			

1.5 Nameplates

Nameplate on the machine

- ❑ Name and address of the manufacturer.
- ❑ Mark showing type of machine.
- ❑ Total weight of the machine.
- ❑ Diameter of the crosscut saw-blade 700 mm, the hole 35 mm.
- ❑ The highest permitted rotational speed 2200 r.p.m
- ❑ Max. hydraulic pressure 200 bar.
- ❑ Serial number and year of manufacture.
- ❑ Nameplate at the rear of the blade housing

Nameplates on the electric drive

- ❑ 3-phase motor.
- ❑ Voltage 230/380 V or 380/600 V, may vary depending on the country.
- ❑ Output 7.5 kW.

1.6 The main dimensions and models of the machine

Machine model	Power 70		Power 70 S	
	TR	TR/SM	TR	TR/SM
DRIVING POWER	TR	TR/SM	TR	TR/SM
Weight	810 kg	900 kg	840 kg	930kg
Powered by electricity	7.5 kW; fuse size: minimum 25A			
Height/width/length	Transport position 2.45m / 1.3m / 2.8m			
In-feed conveyor	Length 2.4m Height 0.9 m			
Diameter of blade/hole	700mm/ 35mm			
Max. rotation speed of blade	2,200 r.p.m.			
Max. diameter of the log	Max. cutting diameter of the log 25cm			
Max./min. length of the log	The maximum length of log that can be split is 60cm.			

- ❑ The 4.3 m firewood conveyor is included in the weight.

1.7 Safety instructions

General regulations and restrictions

- ❑ The maximum length of the log to be cut is 4 metres. Danger of turning over! If no log-stand or log-deck is used.
- ❑ The machine is exclusively intended for the production of firewood.
- ❑ The machine may only be operated by one person.
- ❑ The machine must be equipped with lights for transportation on public roads.
- ❑ When transporting the machine on public roads hitched to the three-point linkage of a tractor, the maximum allowed driving speed is 25 km/h.
- ❑ The danger zone around the conveyor is 5 metres to the sides and to the rear.
- ❑ Lift and lock the infeed deck and the discharge conveyor in the transport position for transportation.
- ❑ The three-point linkage of the tractor is of size-category two. If using a tractor larger in size, check that there is sufficiently space for the PTO shaft and its protective guard.
- ❑ Only persons over 18 years of age are allowed to operate this machine.
- ❑ Never remove any safety-related devices from the machine.
- ❑ The width of the machine equipped with the 4,3-m conveyor is about 2.83 m. This means that, depending on the size of the tractor, the transport width of the conveyor may extend outside the rear wheel on the right-hand side.

The operator

- ❑ Every person operating the machine, must thoroughly study the entire user manual.
- ❑ Always use eye guards and hearing protectors.
- ❑ Always wear protective shoes.
- ❑ Always wear work gloves.
- ❑ Do not wear loosely-fitting clothing.

Before use

- ❑ Always carry out the required preparations on both the machine and the conveyor before starting the operation.

- ❑ Make sure that all other people stay outside the operating range.
- ❑ Only use a fault-free PTO shaft and attach the chain for the shaft-guard. The permissible revolutions range of the PTO shaft is 450-540 r.p.m.
- ❑ Only operate the machine on a sufficiently firm and level surface.
- ❑ Only operate the machine in an adequately lit space.
- ❑ Keep the tractor-powered machine connected to the three-point linkage. Also ensure that sufficient space is provided for the PTO shaft and its guard.
- ❑ Always check that all the covers are intact and properly fastened.
- ❑ Always check that the crosscut saw-bar is intact.
- ❑ Always ensure that the electric conductors are intact.
- ❑ Always check that all the controls are operational.
- ❑ Always check the oil level and make sure that the hydraulic hoses and components are free of damage.
- ❑ Before starting the work, make sure that the machine is firmly in position.

During operation

- ❑ Carelessness during the cut-off operation constitutes a major hazard!
- ❑ During the cut-off operation, make sure that the tree at the cutting point always leans against the support roller of the crosscut deck and the infeed roller: danger of rolling over!
- ❑ Exercise particular caution when cutting knotty or crooked logs, because, as a result of faulty cutting, the log might roll over or twist the saw-bar with enough force to break it.
- ❑ Keep the working space clean and clear of foreign objects.
- ❑ Always stop the machine and disconnect the power supply cable or the power take-off shaft before servicing.
- ❑ Only cut one log at a time.
- ❑ Danger! Stay away from moving parts.

1.8 Noise emission and vibration

Equivalent continuous A-weighted sound-pressure level at the workstation is 88.5 dB (A) and the sound power level is 108.5 dB (A). The vibration emission values do not exceed 2.5 m/s².

1.9 Responsibilities of the operator

- ❑ The machine may only be used to produce firewood.
- ❑ **All the safety-related devices** are necessary to ensure a sufficient level of safety.
- ❑ The Power 70 is a very safe machine provided that the instructions supplied are properly followed, the regular maintenance routines are duly executed and the work is carried out without haste.
- ❑ It is the **responsibility of the operator** to ensure before the work is started that all the safety-related devices are in perfect order and the machine has been serviced in a due manner.
- ❑ The operator is responsible for ensuring that no one else is subjected to any danger.
- ❑ Modifying the construction of the machine is prohibited.
- ❑ The machine must never be operated under the influence of alcohol or drugs.
- ❑ Remember that as the operator you are responsible for any injuries caused if safety-related devices have been removed from the machine.

1.10 Operating conditions

- ❑ Always place the machine on as level a surface as possible.
- ❑ Prevent risks, such as slipping in winter, by organising the work site in a due manner.
- ❑ Otherwise the weather conditions do not set any restrictions on the operation. When starting the machine in severe frost, allow it to idle at about 1/4 of the maximum speed for about 5 to 10 minutes.
- ❑ Only operate the machine in an adequately lit space.
- ❑ It is recommended that a suitable stand be purchased or made that enables the trees to be processed where the logs are ready at the level of the in-feed deck. Hence, unnecessary lifting may be avoided and the work can proceed much faster. We recommend using either the Palax Mega log-deck or the Palax Log log-stand.
- ❑ The most suitable temperature range for operation is approximately - 20 to +30 degrees Centigrade. Otherwise, the weather conditions do not set any restrictions on the operation.
- ❑ Make sure that no other people, especially children, are present inside the operating range.
- ❑ Never use the machine indoors, owing to the risk of dust generation or the danger of exhaust gases.

1.11 Terms of warranty

The warranty period runs for 12 months from the date of purchase.

The warranty covers

- ❑ Parts which have been damaged during normal operation of the machine due to any defects in material or workmanship.
- ❑ The reasonable repair cost as set forth in the agreement between the buyer and the manufacturer.
- ❑ A new part is delivered as a replacement for the defective one.

The warranty does not cover

- ❑ Defects due to normal wear, faulty operation or negligent maintenance.
- ❑ The crosscut saw-blade, V-belts and oils.
- ❑ Defects in the machine due to any modifications which the buyer has made or ordered from a third party and which have affected the machine in such a way that it can no longer be considered to correspond to its original configuration.
- ❑ Other possible expenses or financial claims due to the above-mentioned measures.
- ❑ any indirect costs and/or travel expenses incurred from making repairs under the guarantee.
- ❑ For parts changed during the warranty period, the warranty expires at the same time as the warranty period of the machine.
- ❑ Consult your dealer about matters related to the warranty.

1.12 Operating instructions for the winch

Please refer to the user manual of the winch or visit our website at www.palax.fi for more detailed operating instructions for the winch.

2 Taking delivery and setting up the machine for operation

2.1 Lifting the machine

- ❑ There are lifting lugs for lifting the machine with a crane at both ends of the machine, at the rear edge of the splitting chute and at the rear edge of the infeed deck.
- ❑ The machine can be lifted with a forklift truck from both sides. There are guide rails for lifting forks under the chassis.

2.2 The transport set-up and unpacking

- ❑ The machine is delivered almost ready assembled and with the conveyor attached.
- ❑ In order to avoid damage during transportation, the machine is delivered partly dismantled so that all the protruding levers and the hitching parts of a tractor-powered machine have been removed and packed separately.
- ❑ The extension table for the infeed conveyor and the loading conveyor are in the transport position.
- ❑ The angular gear is filled with transmission oil.

2.3 Acceptance inspection

- ❑ Check the delivered goods without delay.
- ❑ If the product shows transport damage, contact the transport company and your dealer immediately.

2.4 Main parts of the machine, Fig 1

1. Infeed conveyor support
2. Infeed conveyor belt
3. In-feed conveyor
4. Conveyor support
5. Emergency stop lever, tractor-powered machine
6. Blade cover
7. Multi-function lever, crosscut and infeed operations
8. Protective net for splitting chute
9. Adjustment lever 12 for the splitting wedge
10. Conveyor

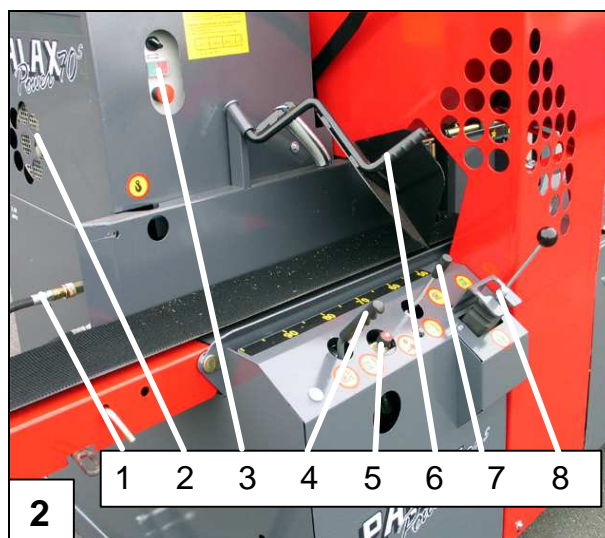
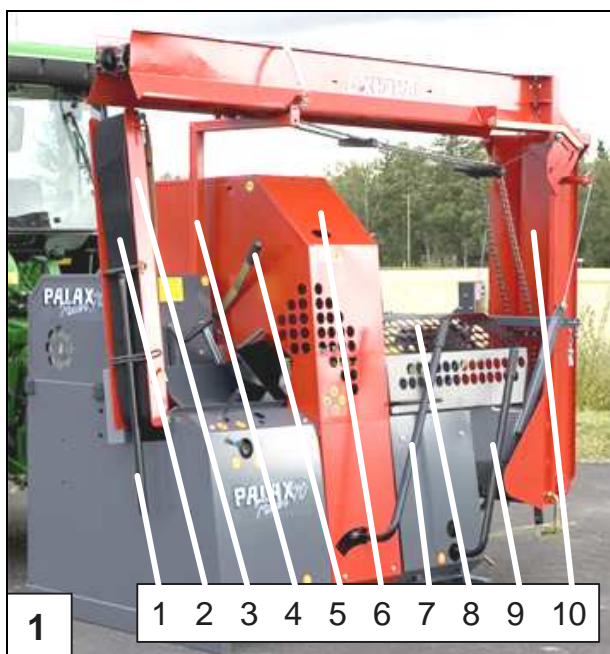

2.5 Operating controls of the machine, Fig. 2

1. Optional hydraulics
2. Electric motor
3. Y/D starter
4. Manual start of the splitting cylinder
5. Adjustment of proceeding speed of the crosscut saw-blade
6. Log-clamp
7. Hydraulic height adjustment of splitting wedge
8. Joystick valve for controlling the cutting, launching of splitting and infeed conveyor operations

2.6 Table extension, Fig. 3

1. Disconnect the rubber strap A.
2. Pull open the locking lever B.
3. Swing the conveyor down and place the leg into the opening C in the frame. Re-connect the rubber strap.

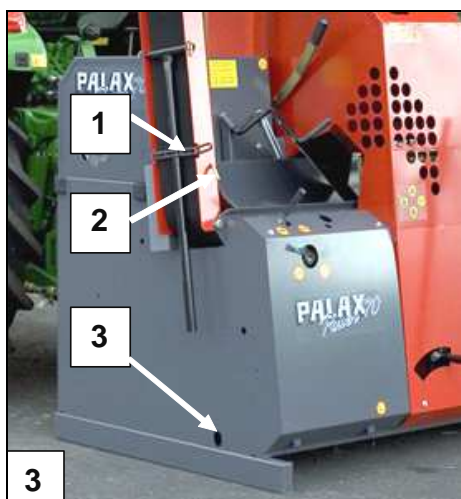

2.7 Bringing the conveyor into the work position, Figs. 4, 5, 6 and 7

- ❑ Remove the locking pins A for the conveyor, Fig. 4 and 5.
- ❑ Release the locks B, Figs. 4 and 5.
- ❑ Unwind the winch wire a few rounds.
- ❑ Pull out the conveyor and leave it supported by the winch rope.
- ❑ Lower the conveyor to the ground using the winch.

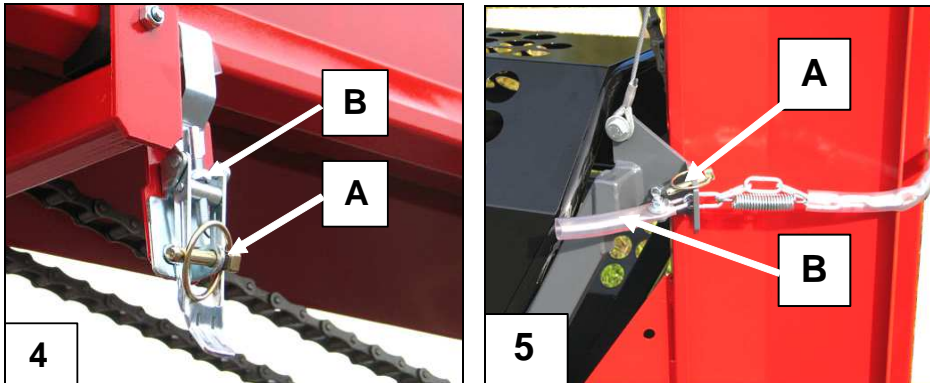

- ❑ Pull open the lock A, Fig. 7
- ❑ Swing down the top of the conveyor.
- ❑ Remove the support bar B for the conveyor chain, Fig. 7, and attach it to the holes C at the edge of the conveyor.
- ❑ Put the splints back in place.

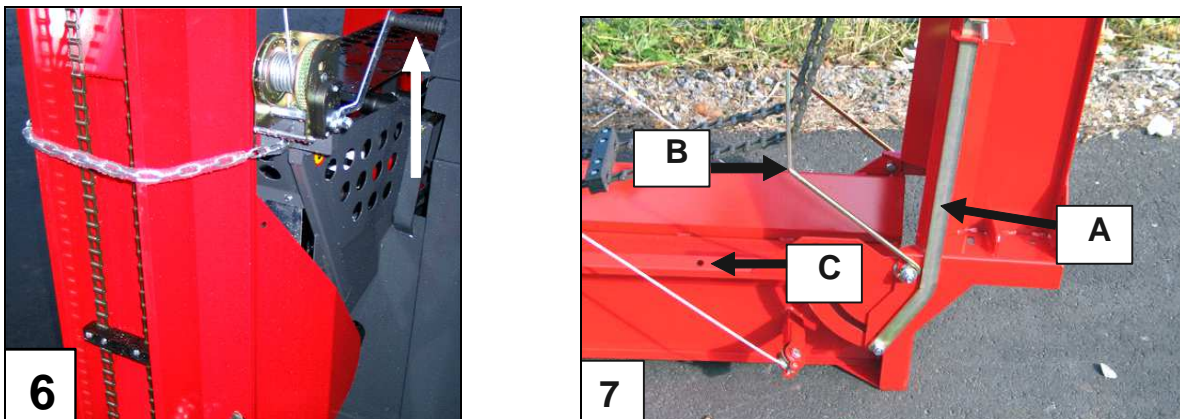

WARNING!

Always hold by the winch handle as you lower the conveyor.

2.8 Bringing the conveyor into the transport position, Fig. 4, 5, 6 and 7

- ❑ Release the locks for the conveyor.
- ❑ Lower the conveyor to the ground and connect the support bar B for the conveyor chain, Fig. 7.
- ❑ Pull lock A open and lift up the conveyor top.
- ❑ Ensure that lock A is properly locked.
- ❑ Raise the conveyor using the winch.
- ❑ Tighten the winch wire lightly in order to prevent it uncoiling from the spool.
- ❑ Lock the conveyor to the transport support using the lock, the chain and the pin.

Adjusting the log-stop, Fig. 8

- ❑ The log-stop A can be set to any position between 25 and 60 cm.
- ❑ Set the desired cutting length using the scale, and tighten the log-stop screws with a wrench.
- ❑ As the crosscut blade lowers, the log-stop automatically turns away from the log, allowing it to fall down freely.
- ❑ The log-stop is equipped with two shear-pins B.
- ❑ The shear-pins are intended for protecting the log-stop structure against damage that may occur if a tree of excess length ends up in the splitting chute and the pusher pushes it to a vertical position against the log-stop.
- ❑ Bolt size M 6 x 100, partial thread, strength class 8.8, M6 Nyloc nut.

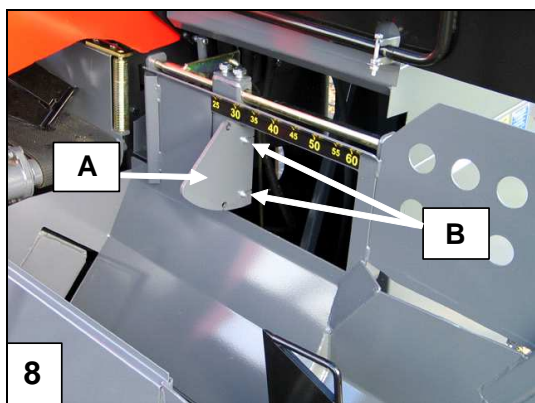

NOTE ! Always put the nut on the log-stop plate side.

3 Operation of the firewood processor powered by different power sources

3.1 Powered by a tractor

- ❑ The PTO shaft must be able to transmit an output of about 26 kW: for example, BONDIOLI 143, WALTERSCHEID W 2300 or EGT40.
- ❑ No safety clutch is required for the PTO shaft.
- ❑ Only use fault-free PTO shafts and always attach the chains for the shaft-guard to the machine.
- ❑ When you disconnect the PTO shaft from the tractor, hang it in the hook on the machine.
- ❑ If the power take-off of the tractor has a high-speed range, it is recommended to use it, because the horsepower requirement of the Firewood Processor is small. The suitable range of speeds for the PTO shaft is from min. 450 to max. 540 rpm.

3.2 Emergency stop switch of the tractor powered machine, Fig. 9

- ❑ The tractor-powered machine is equipped with a special Rapid Stop Device which disengages the transmission from the angular gear to the machine in a matter of seconds and stops the operation of the machine completely.
- ❑ In an emergency situation, push lever A upwards to the point where it locks. In this position, the drive belts are loose.

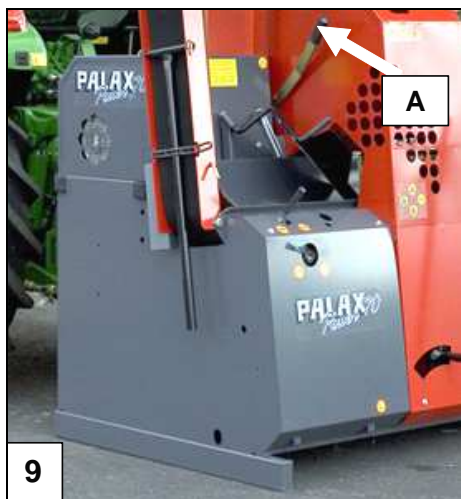

NOTE ! Only use the lever in an emergency, because the V-belts, which slightly chafe the angle-drive pulley, may wear too quickly.

3.3 Required measures in an emergency situation

If the switch has been used in an emergency situation, e.g. when a log has stuck in the circular saw-blade as a result of a mistake during the sawing, immediately also switch off the power take-off transmission of the tractor, because the pulley of the angle drive can wear down the V-belts unnecessarily.

NOTE ! Switch the Rapid Stop Device back to the operation position before engaging the transmission of the tractor.

3.4 Starting under cold conditions

- When starting the machine in severe frost, allow it first to idle at low speed for about 5 minutes; this warms up the oil. Warming up the oil reduces wear on the hydraulic system significantly and prevents damage.

3.5 Electric drive, start and emergency stop, Fig. 10

- The power output of the motor is 7.5 kW and the speed is 1,480 rpm.
- The machine is equipped with an automatic Y-D starter with an emergency stop feature.
- All the electric installations have been made ready.
- The cross-section of the extension cord required for a tension of 380 V must be at least 6 mm². Fuse size: minimum 25A
- When starting up the machine, check that the direction of rotation corresponds to the arrow at the end of the motor.
- To check the direction of rotation, run the motor for a short while and then stop it suddenly.
- The motor A and the starter B are located under the protective cover.

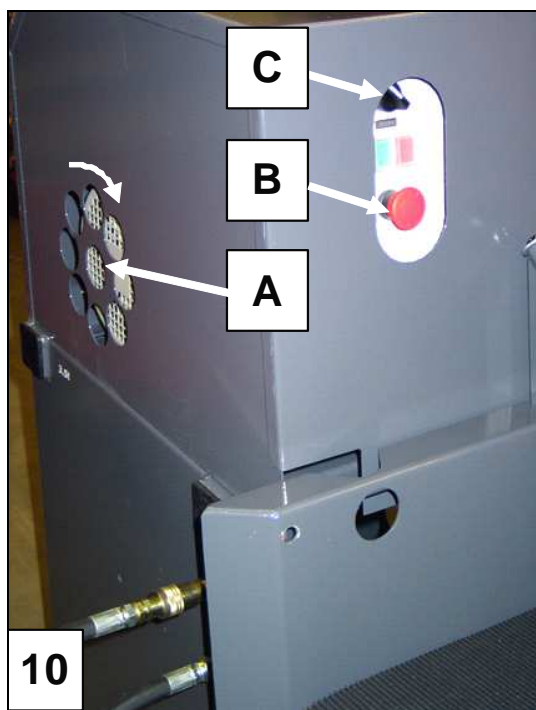

NOTE ! Only a skilled craftsman is allowed to change the direction of rotation.

NOTE ! Only use an extension cord equipped with a changeover switch for rotation direction of the motor that can be turned by screwdriver.

3.6 Starting the electric motor

- ❑ Press the start button. In the Y-position the motor starts rotating at slow speed with low output. The start phase takes several tens of seconds.
- ❑ As the engine speed increases, the D-position is switched on and the motor quickly reaches full speed. As the motor reaches full revolutions, the signal light on the starter illuminates.

NOTE ! The machine must not be operated until the motor is running at full speed.

3.7 Emergency stop of a machine powered by electric motor, Figure 10

- ❑ Push down the emergency stop button B.
- ❑ Turn the pushbutton clockwise to release it.

3.8 The machine is equipped with a system to prevent simultaneous operation in two modes, Fig. 11

- ❑ When the cover plate C is turned down, it is possible to connect the extension cord. When the cover is turned up, it is possible to connect the PTO shaft.
- ❑ Suspension hook A for the power take-off shaft.

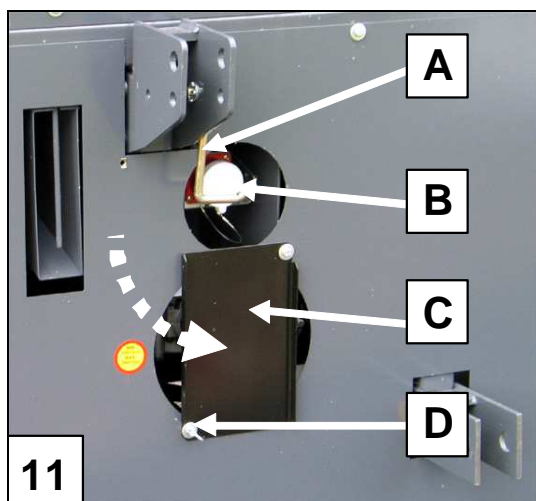

WARNING! Never remove from the machine the plate that prevents the simultaneous operation in two modes. Always remove the power take-off shaft before operating the machine by electricity.

3.9 Operation under cold conditions

When an electric motor-powered machine is operated in temperatures below -15 degrees Centigrade, the use of a less viscous hydraulic oil is recommended, because a machine with electric drive takes full revolutions right from the start of operation. Suitable oils are, for example, ISO VG22S multigrade oil or synthetic hydraulic fluid.

Electric heater for oil tank, Fig.12

- ❑ A 300 W electric heater carpet with adhesive tape attachment and thermostat is available as an option for the hydraulic oil tank.
- ❑ The starter comes as standard equipped with operating switch for the heater. Fig 10C.
- ❑ Heating the oil for 1-2 hours is sufficient to enable smooth starting.
- ❑ The size of the heater carpet is 200 x 300 mm.
- ❑ Capacity 300 W.
- ❑ Equipped with thermostat.
- ❑ Strongly adherent glue for attachment of the carpet.

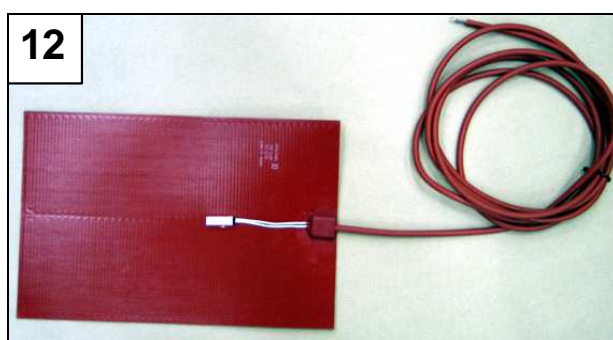

NOTE ! Only a skilled craftsman is allowed to carry out electrical work for the heater.

4 Fully hydraulic control of the Power 70 s firewood processor, Fig 13

- Cross-cutting, start of the splitting and operation of the in-feed conveyor are effortlessly controlled using the fully hydraulic joystick-valve 1, Fig.13.

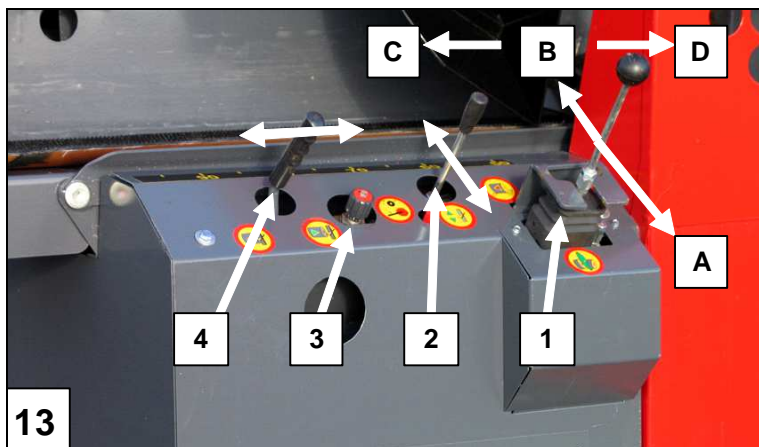

4.1 Mastering the safety devices

1. The crosscut blade does not come down - close the protective net for the splitting chute. The machine does not operate, if the protective net is open.
2. The protective net for the splitting chute cannot be opened – lift the crosscut blade to its upper position. The protective net cannot be opened if the crosscut blade is not in the upper position.
3. The splitting operation cannot be launched with manual control – close the protective net for the splitting chute. The machine does not operate, if the protective net is open.

4.2 Joystick-valve, No. 1, Fig. 13

- Push the joystick forward and move it in direction B – D; the conveyor feeds the log against the log-stop.
- Push the joystick forward and move it in direction B – C; the conveyor reverses.
- Pull the joystick back in direction A; the saw-blade comes down and cuts through the wood.
- Push the joystick forward in direction B; the crosscut blade comes up and, at the same time, launches the splitting.

4.3 Operating lever for the splitting wedge No. 2, Fig. 13

- Pull it back, the splitting wedge lowers.
- Push it forward, the splitting wedge raises.

4.4 Adjustment valve No.3 for proceeding speed of crosscut blade, Fig. 12, only in s-model

- When the valve is turned clockwise, the proceeding speed decreases, and when turned counter-clockwise, it increases.
- For thick logs, it pays to reduce the proceeding speed. This decreases the load on the transmission and the crosscut blade.

- Reducing the proceeding speed slightly does not affect the total processing time, because splitting a thicker log also takes more time.

4.5 Joystick-valve, No. 4, Fig. 13

- Press the lever to the right to launch the splitting.
- Press the lever to the left to stop the splitting and to reverse the cylinder.

5 Mechanical control of the Power 70 firewood processor using the multi-function lever

The crosscut operation, launching the splitting and operation of the infeed conveyor are effortlessly controlled using multi-function lever 3, Fig. 14. The movement path and all movements are precise as the shaft and the controls are all equipped with roller bearings.

5.1 Mastering the safety devices

1. The crosscut blade does not come down - close the protective net for the splitting chute. The machine does not operate, if the protective net is open.
2. The protective net for the splitting chute cannot be opened – press the multi-function lever completely to the right. The protective net cannot be opened, unless the multi-function lever is positioned completely to the right.
3. The splitting operation cannot be launched with manual control – close the protective net for the splitting chute. The machine does not operate, if the protective net is open.

5.2 Control levers for Power 70, Fig. 14A

1. Manual start of the splitting.
2. High-speed valve with manual operation.
3. Multi-function lever.
4. Control lever for splitting wedge.

Operation of the multi-function lever 3, Fig. 14A

- Direction A, crosscut operation.
- Direction A; raising the crosscut blade and simultaneous launching of the splitting. In the extreme position to the right, the functions are locked, enabling opening of the net cage.
- Direction C; as the crosscut blade is raised to its upper position, the lever 3 can be pressed in direction C to advance the log using the infeed conveyor.
- Direction D; in the same position, the lever can be pulled out to make the infeed conveyor reverse.
- An automatic high-speed valve is available as an option for the Power 70 model.

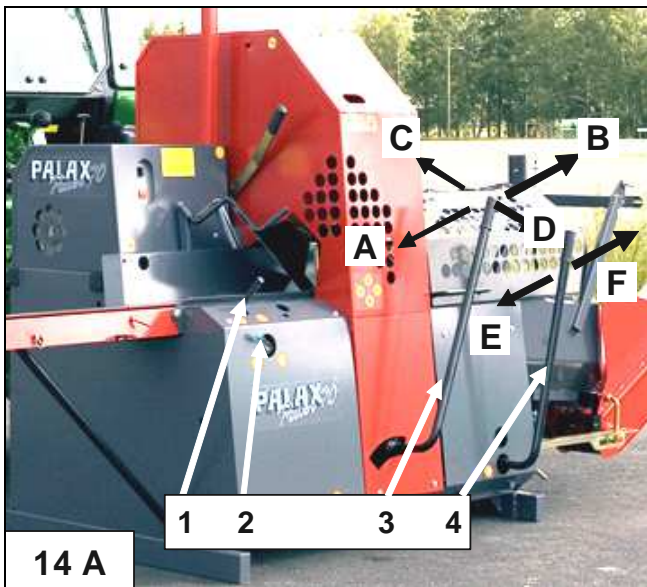

Installing the adjustment lever for the splitting wedge, Fig. 14B

- In order to prevent transport damage, the adjustment lever for the splitting wedge has been removed.
 1. Put the adjustment lever in place.
 2. Look up the correct installation procedure for the friction plate and spring washers on the sticker.
 3. Wrench the crown nut to suitable tightness and put the splint in place.
 4. The tightness of the nut is correct when the adjustment lever is easy to operate but the splitting wedge stays well in its upper position.

6 Use of the firewood processor, crosscut operation

NOTE ! The machine is intended for operation by one person only. Never leave the machine, which is easy to start, unattended.

6.1 Operating the crosscut saw, before the operation

- Cleanse the new saw-blade of any protective grease, because a greasy blade accumulates resin easily, making it heat up. The blade then loses its tension, and starts to jerk.

6.2 During the operation

- Exercise caution, always keep your hands away from the saw-blade.
- Do not cut slender logs more than one at a time, because if many logs are being cut at the same time, some of them may twist the blade strongly, causing it to heat up and lose its tension.
- Never stop the rotation of the blade by pressing wood against it.
- During the crosscut operation, make sure that at the cutting point the log always leans against the support roller and the infeed roller.
- Keep the log-pusher handle pushed down during the sawing to keep the log reliably in position on the deck. This is important with slender logs and, generally, when the last piece is being cut and the log is short and lightweight.
- Cut very crooked trees where they bend. Doing so makes the crosscut operation significantly easier.

WARNING! Crooked trees may be turned on the deck by the cutting force thus twisting the blade so strongly that it breaks.

6.3 Cutting to equal length and feeding into the splitting chute

- ❑ Cut off the undersized piece while there is still sufficiently material for one or two more pieces of appropriate size left in the billet.
- ❑ Use the scale A at the edge of the infeed deck as an aid, Fig. 15.

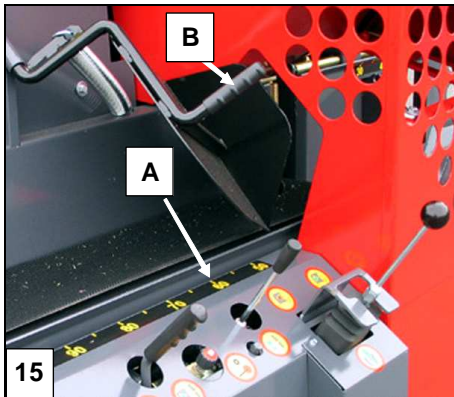

NOTE ! While cutting the last logs and, generally, always when processing slender trees, increase the force on the clamp by pressing the handle B, Fig. 15. This is a safe way to cut short and light-weight trees so that the tree cannot roll.

6.4 Feeding the last log for splitting

- ❑ Using the conveyor, feed the last log onto the pusher without delay as the pusher is still splitting the previous log.
- ❑ As the pusher reverses, the log falls into the splitting chute and the splitting operation can be launched manually immediately.
- ❑ This notably speeds up processing of the firewood.

WARNING! Make sure that the tree always remains under the clamp during cutting. The minimum length for the log is 25 cm.

7 Disturbances during crosscut operation and their remedy

7.1 Crooked trees

- ❑ Cut crooked trees where they bend.
- ❑ As you cut crooked trees, make sure that the log is leaning against the support roller.

7.2 Big trees

- ❑ If the cutting sound is soft, the cutting speed and the saw-blade revolutions are correct.
- ❑ If the cutting sound is loud and cracking, the saw-chain is proceeding too fast and the sawdust grooves are getting clogged. Check the rotational speed, proceeding speed of the crosscut blade and sharpness of the blade.
- ❑ If the tree gets stuck in the blade as a result of faulty cutting, stop the machine immediately. For the electric motor-powered machine, use the emergency stop switch, and for the tractor-powered machine, use the clutch.

- ❑ Also disengage the power take-off shaft.
- ❑ Before continuing the operation, inspect the stuck saw-blade for any cracks at the roots of the teeth.

WARNING! A faulty saw-blade must not be used for cutting.

7.3 Cutting of small trees without splitting

- ❑ It is also possible to cut small logs quickly by first removing the wedge. The piece of firewood then goes straight onto the conveyor without splitting.

7.4 Disturbances during the splitting operation and their remedy

A stuck log

- ❑ As the logs are big and have big branches, the cylinder force may not be sufficient.
- ❑ If the log sticks to the wedge, reverse the cylinder using the manual control.
- ❑ Lift up the splitting wedge slightly and retry the splitting by manual operation. Changing the position of the log helps in many cases.
- ❑ If the log will not split, open the cover and knock the stuck log loose using another log.
- ❑ If there is a big branch on the log, turn the log around so you are able to split the branch by pushing the log against the wedge with the butt-end first. Doing it this way requires the least power.

7.5 Re-splitting the logs safely

- ❑ If you want to produce small-size firewood from large logs, even wood split by the 4 or 6-way wedge may still be too large in size.
- ❑ Proceeding in the following way will help you to split the wood safely into even smaller pieces.
 1. Open the cover.
 2. Place the logs to be split into the splitting chute. E.g. one on top of the other. The pieces of wood will stay in this position, if you hit them carefully against the wedge.
 3. Close the cover and start the splitting using the lever for manual control.

8 Accessories for the firewood processor

8.1 Splitting cylinder

- ❑ The machine can be equipped with a splitting cylinder of either 3,5 tons or 5,6 tons.

8.2 Manually-operated high-speed valve, Figure 16

- ❑ The Palax Power 70 model is equipped as standard with a high-speed valve with manual operation which makes splitting of small trees much faster. The high-speed valve is intended for small trees, i.e. trees less than 15 cm in diameter. When the high-speed valve is applied, the splitting force is about half that at full power.
- ❑ The operation of the high-speed valve is based on the fact that splitting of small logs does not require full power.
- ❑ If the cylinder force is not sufficient to enable splitting of the wood with the high-speed movement, turn the control lever of the valve to the normal position. The machine does not need to be stopped for switching.



NOTE ! Use the high-speed option only for such slender trees that you know by experience, will definitely split up. If the power repeatedly falls short, the transmission will be subjected to strain and the oil will heat up unnecessarily.

8.3 Automatic high-speed valve

- The Palax Power 70 s model is equipped with automatic high-speed valve as standard.
- The valve reduces the splitting speed only when the pressure exceeds 120 bar.
- As the tree starts splitting and the pressure decreases, the high-speed movement is immediately resumed.
- The valve speeds up even the splitting of thick logs, as the stroke approaching the wedge occurs at high speed.

8.4 Splitting wedges

Standard wedge

- The 2/4 wedge for splitting the wood in 2 or 4 ways.

Optional wedges

- The short straight wedge for splitting the wood in 2 ways or, if the wedge is lowered, no splitting will take place.
- The 2/6 wedge for splitting the wood in 2 or 6 ways. Normally requires a cylinder of 5,6 tons.

9 Maintenance of the machine

NOTE ! Always stop the machine before servicing.

9.1 Removal and change of the crosscut blade, Fig 17 and 18

1. Remove the attachment screws of the cover net, a 13 mm wrench.
2. Swing the large cover net open.
3. Insert pin A, Fig. 17, into the hole in the V-belt pulley to prevent the blade from rotating and twist off the blade nut, right-hand thread, a 36 mm wrench. The thread on the nut is M 24 x 2.
4. Carefully clean the surfaces of the flanges before re-installation of the blade.

5. Before installing the blade, make sure that the pin, which prevents the saw-blade from rotating, is in place.
6. Remove pin A after changing the blade and place it in the holder.

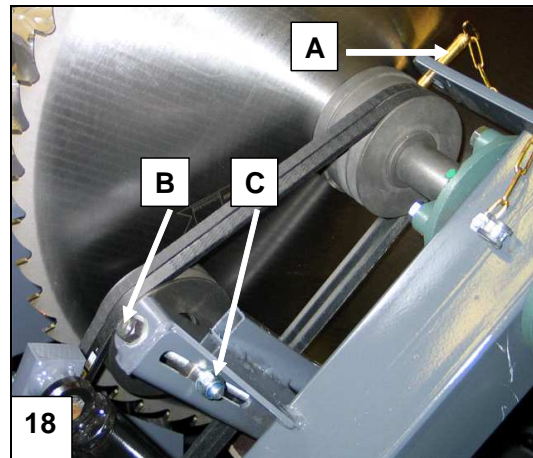
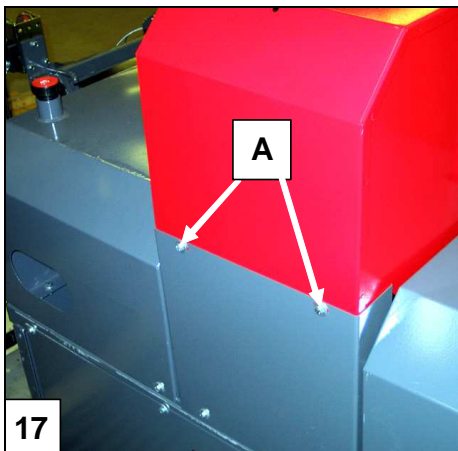

9.2 Tightening the V-belts, centre shaft/blade shaft, Fig. 18

1. Retighten the V-belts the first time after 4-8 hours of operation.
2. Check the belts for tightness at regular intervals.
3. The tightness is correct when the belt on the underside sags by 10-15 mm when pressed down by a force of about 2-3 kg.
4. Tightening: loosen the nut C slightly, not too much, then tighten the screw B, tighten the nut C and check once more the tightness.

9.3 Replacement of the V-belts, centre shaft / saw-blade shaft

1. Remove the crosscut blade, as instructed in point 9.1.
2. Remove the attachment flange of the oil pump, 4 pcs. of M 10 screws, 17 mm wrench.
3. Slacken the tightening device of the belt.
4. Change the belts. Only use V-belts obtained from an authorised dealer.
5. Carefully clean the surfaces of the flanges before re-installation of the blade.
6. Before installing the blade, make sure that the pin, which prevents the saw-blade from rotating, is in place.
7. Attach the cover net.

9.4 Sharpening the blade, hard-metal blade

- ❑ The hard-metal blade can be sharpened "lightly" using a diamond file.
- ❑ Depending on the cleanliness of the wood, as many as 500-1000 bulk cubic metres of wood can be processed with a hard-metal saw-blade without resharping.
- ❑ The best sharpening result and durability of the blade is achieved when the saw-blade is sharpened using an appropriate grinding machine with a diamond disc.

9.5 Setting the saw-blade, hard-metal blade

- ❑ Stressing-faults do not usually occur in hard-metal blades. But especially, when a blunt saw-blade is used for cutting and it gets very hot, stressing-faults can occur.
- ❑ Leave the prestressing of the hard-metal blade to a professional.

9.6 Spare blade

- If you process a lot of firewood, obtain a spare blade.

9.7 Tightening the V-belts, angular gear /centre shaft

- The V-belts between the angular gear and the centre shaft are tightened automatically by the spring force and the pressure roller.
- The V-belts are kept tight through depressing the pressure rollers A by the spring force against the V-belts on their slack side.

9.8 Replacement of V-belts, angular gear /centre shaft

1. Remove the rear cover plate from the machine.
 2. Slacken the V-belts using the emergency stop lever.
 3. Replace the old belts with the new ones. Only use V-belts obtained from an authorised dealer.
 4. Tighten the V-belts using the emergency stop switch.
 5. Replace the rear cover.
- If the machine is equipped with an electric motor, loosen the attachment of the motor and move the motor outward as much as is necessary to slip the belts between the claws of the claw clutch.

9.9 Tightening the infeed conveyor belt, Fig. 19A

- There are tightening screws between the infeed conveyor and the extension deck, which can be used for tightening the belt.
- As you tighten the belt, make sure that the belt travels in the centre of the roller.
- Ensure that the scraper C is as close to the roller as possible. The scraper is intended for always keeping the roller clean and ensuring that the belt runs straight.
- Using the adjustment screw (19B) at the blade end of the feeder belt, you can change the course of the band so that it will run straight.

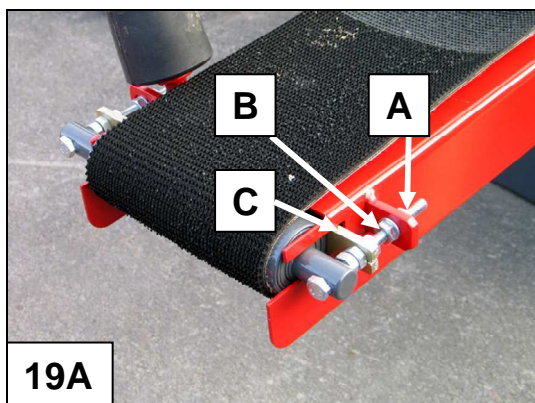

9.10 Replacement of the infeed conveyor belt

1. Disconnect the hoses from the hydraulic motor.
2. Protect the couplings in order to prevent contaminants from entering the hoses.
3. The infeed conveyor is attached by 5 screws. Remove the screws and lower the conveyor to the ground on wooden supports.
4. Loosen the tightening screws for the belt.
5. Change the belt. Note. Only use a conveyor belt obtained from an authorised dealer.
6. Put the conveyor back in place, connect the hydraulic hoses and tighten the belt.

9.11 Direction of rotation of the belt

- ❑ Check the correct direction of rotation of the belt in accordance with the arrow, while replacing the belt.
- ❑ During the infeed operation, the belt must run in the direction of the arrow.
- ❑ The belt joint may break, if the belt is installed in the wrong way.
- ❑ Check the belt for tightness at regular intervals.
- ❑ The drive roller must not slip.

9.12 Changing the oil in the angular gear

1. Remove the oil plug, Fig. 20, and drain the used oil, for example, by using a suction drainage device or removing the angular gear in its entirety.
2. Fill up with about 0.5 litres of new oil; SAE 80.

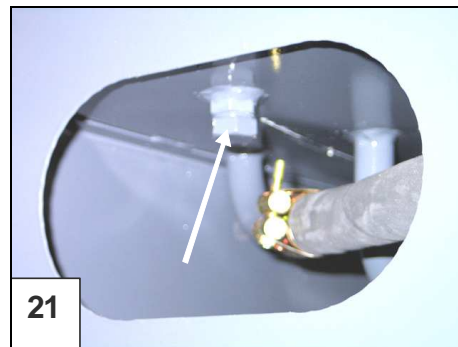
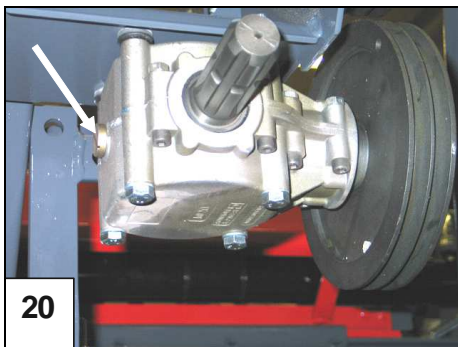

9.13 Changing the hydraulic oil, Fig. 21

- ❑ The normal hydraulic oil volume is 40 litres. In professional use, the oil volume is 60 litres.
- ❑ The quality of oil should be ISO VG 32, e.g. Univis 32, SHELL Tellus 32, NESTE HYDRAULI 32 or equivalent.
- ❑ For continuous operation under warm conditions, use ISO VG46.
- ❑ If a machine powered by electric motor is operated in temperatures below -15 degrees, it is recommended that a less viscous hydraulic oil be used, e.g. ISO VG 22S multigrade oil or synthetic hydraulic fluid, because a machine with electric drive works at full speed right from the start of operation
- ❑ Observe particular cleanliness during the oil change, because the flawless operation of the machine is highly dependent on the purity of the oil.

9.14 Lubricating the machine: refer to the Maintenance Schedule

- ❑ Nipples for bearings on the multi-purpose shaft, 2 pcs., Fig. 22 A.

- Nipples for multi-purpose shaft, 1 pc., Fig. 22 B.
- Blade beam bearings, 6 nipples, Fig. 23 A.
- Spherical bearings on the operating levers for the blade, 3 nipples, Fig. 23 B.

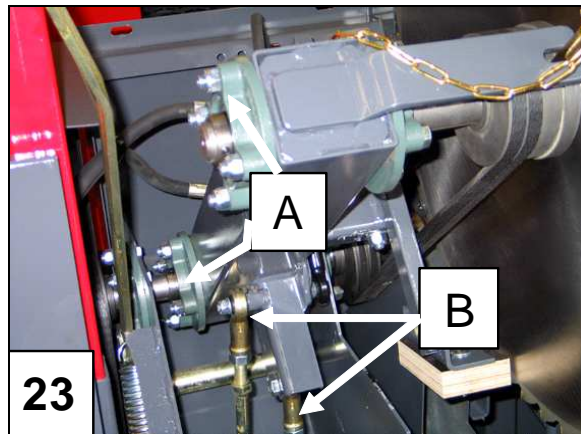
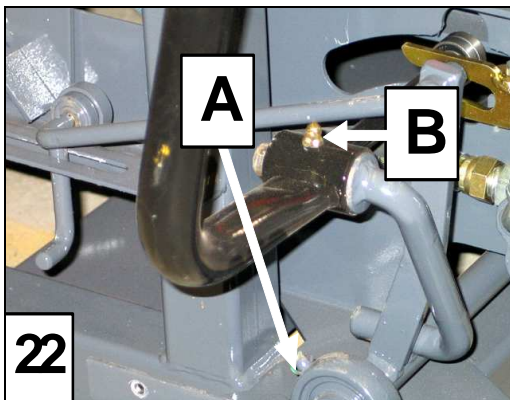

9.15 Servicing the main valve, Fig. 24

- To withstand and operate flawlessly, the detent end A, the spool shifter joint B and the ball joint of the control valve require regular lubrication. Lubrication of the valve is particularly important if the machine is to be left standing for several months. If the parts of the detent have become rusty, the machine will not operate flawlessly.



9.16 Detent end of the valve, Fig. 24 A

- There is a small hole in the middle of the end plate of the detent end of the valve for spraying lubricant onto the moving parts of the valve detent.
- Only use oil that does not congeal in frost.
- The easiest way is to use a spray bottle with a nozzle and pipe, Fig. 25.
 1. Remove the cap screw on the end plate.
 2. Insert the spray pipe in the hole and press 2-3 times for about 1 second at a time.
 3. The oil spreads smoothly on the moving parts of the detent end.

9.17 Lubricating the spool shifter, Fig. 24 B

- The spool shifter is equipped with a pin and a ball joint that require regular maintenance and lubrication.
 1. Lift up the edge of the protective rubber of the spool shifter.
 2. Spray lubricant on both sides of the pin and on the ball joint.
 3. At the same time, check that the rubber is intact.

9.18 Structure of the detent end and the correct order of the parts, Fig. 26

Keep cover C of the detent end depressed while opening screws C, as the stiff springs can throw the cover off. This can also make the springs and balls of the detent fly off. In connection with assembly of the detent end, apply a small amount of Vaseline to holes A of the detent. This ensures the balls stay properly in position during assembly. Make sure that parts D and E line up in the right way, as shown in the picture, and that the condensed-water drain holes always point downward.

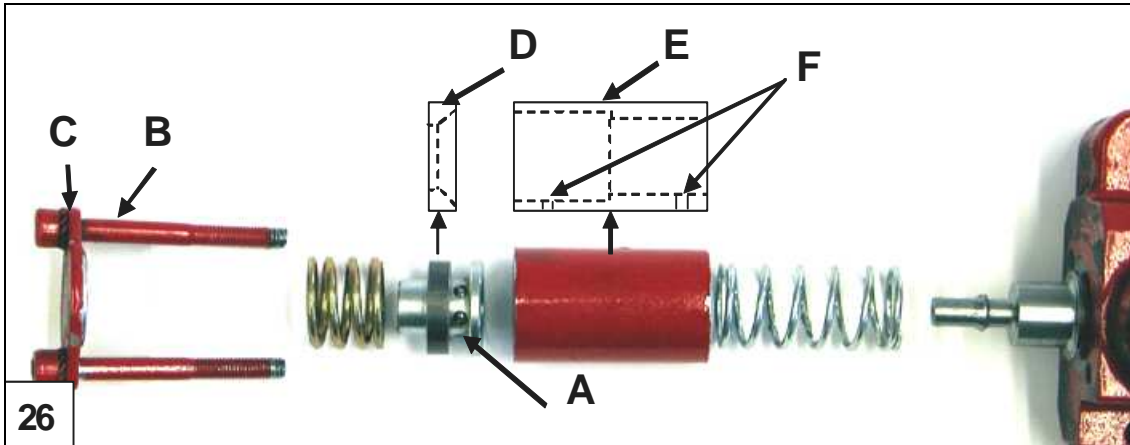

9.19 Initial settings of the valve

The valve has been adjusted and test run at the factory. The initial settings do not usually change so there is rarely any need for readjustment.

9.20 Tightening and lubrication of the conveyor chain, Fig. 27

- ❑ The conveyor is hydraulically driven and equipped with automatic tightening of the chain.
- ❑ The chain shall be lubricated lightly every day.



9.21 Cleaning the conveyor

- Keep the conveyor free of debris to ensure its trouble-free operation.
- Especially in winter, it is important that the conveyor is always cleaned at the end of every working session.
- The conveyor can also be washed with a high-pressure washer.

9.22 Washing the machine

- Wash the machine occasionally with a high-pressure cleaner. This is especially important if the machine is left standing for a longer period of time. Lubricate the machine after washing.
- Note! Do not direct the water jet onto electric devices or bearings.

9.23 Storing the machine.

The machine is intended for outdoor use, but it is recommended to keep it under cover or in doors for longer standstills to avoid corrosion and related malfunctions.

10 Maintenance schedule

Object	Task	Daily	Service interval 100 h	Service interval 500 h	Service interval 1000 h	Material /Method
Angular gear TR -powered	Check 1 Change 2 Change		X	X	X	SAE 80 0,5 l Suction drainage
Hydraulic oil Normal conditions	Check 1 Change 2 Change		X	X	X	Volume 40 l E.g. Esso Unavis 32 Neste Hydraul 32
Oil filter	1 Change 2 Change			X	X	FIO 60/3
Blade-shaft bearings	Lubrication		X			Ball-bearing lubricant
Valve	Lubrication		X			Lubrication oil, spray
All levers	Lubrication	X				Lubrication oil
V-belts Angular gear Blade shaft	Check and tighten as required					SPA 1732 SPA 1457
Crosscut saw-blade	Sharpen as required					700-35-0 degrees
Machine	Cleaning	X				
Electric motor	Cleaning	X				
Electric equipment	Cleaning	X				

11 Malfunctions and their remedy

Disturbance	Cause	Remedy
The crosscut saw-blade is heavy on power and gets hot.	<ol style="list-style-type: none"> 1. The blade is dull. 2. Too much resin in the blade. 	<ol style="list-style-type: none"> 1. Sharpen the saw-blade. 2. Clean the blade.
The saw-blade wobbles. The crosscut blade starts to wobble after a short period of working.	<ol style="list-style-type: none"> 1. Impurities between the flanges. 2. Blunt blade and problems with stressing. 3. Faulty crosscut operation, the log has rolled over 	<ol style="list-style-type: none"> 1. Clean the flanges and the blade. 2. Sharpen and pre-stress the blade 3. The blade is damaged, do not use. Replace the blade.
The blade whines.	<ol style="list-style-type: none"> 1. Too high speed, max. 2200 r.p.m. 2. Root-crack at the tooth 	<ol style="list-style-type: none"> 1. Decrease the speed 2. Do not use, replace the blade.
The saw-blade rotates in the wrong direction.	<ol style="list-style-type: none"> 1. Wrong phase-order. 	<ol style="list-style-type: none"> 1. Use a cord with a phase switch, and switch the phase.
The electric motor does not start.	<ol style="list-style-type: none"> 1. Emergency stop button has been depressed. 2. Makes loud noise, but does not start. 	<ol style="list-style-type: none"> 1. Reset the emergency stop 2. The fuse has blown, replace it.
The motor stops several times and the thermo-relay trips.	<ol style="list-style-type: none"> 1. The blade is dull. 2. Incorrect setting of the thermo-relay. 	<ol style="list-style-type: none"> 1. Sharpen the saw-blade. 2. Contact the manufacturer of the electric motor.
Whining sound during the sawing operation and the revolutions drop.	<ol style="list-style-type: none"> 1. V-belts are slack. 2. V-belts are worn 	<ol style="list-style-type: none"> 1. Tighten the belts. 2. Change the belts.
Blade does not come down Power 70 and 70s	<ol style="list-style-type: none"> 1. Protective cover for the chute is open 	<ol style="list-style-type: none"> 1. Close the cover
Protective cover for the chute cannot be opened Power 70	<ol style="list-style-type: none"> 1. Crosscut blade not in its upper position 	<ol style="list-style-type: none"> 1. Press the multi-function lever to its furthest position on the right
Protective cover for the chute cannot be opened Power 70 s	<ol style="list-style-type: none"> 1. Crosscut blade not in its upper position 	<ol style="list-style-type: none"> 1. Start the machine and lift the blade using the joystick-valve. 2. See point 4. 1-4
Splitting cannot be launched manually	Protective cover for the chute is open	Close the cover

12 Electric diagrams

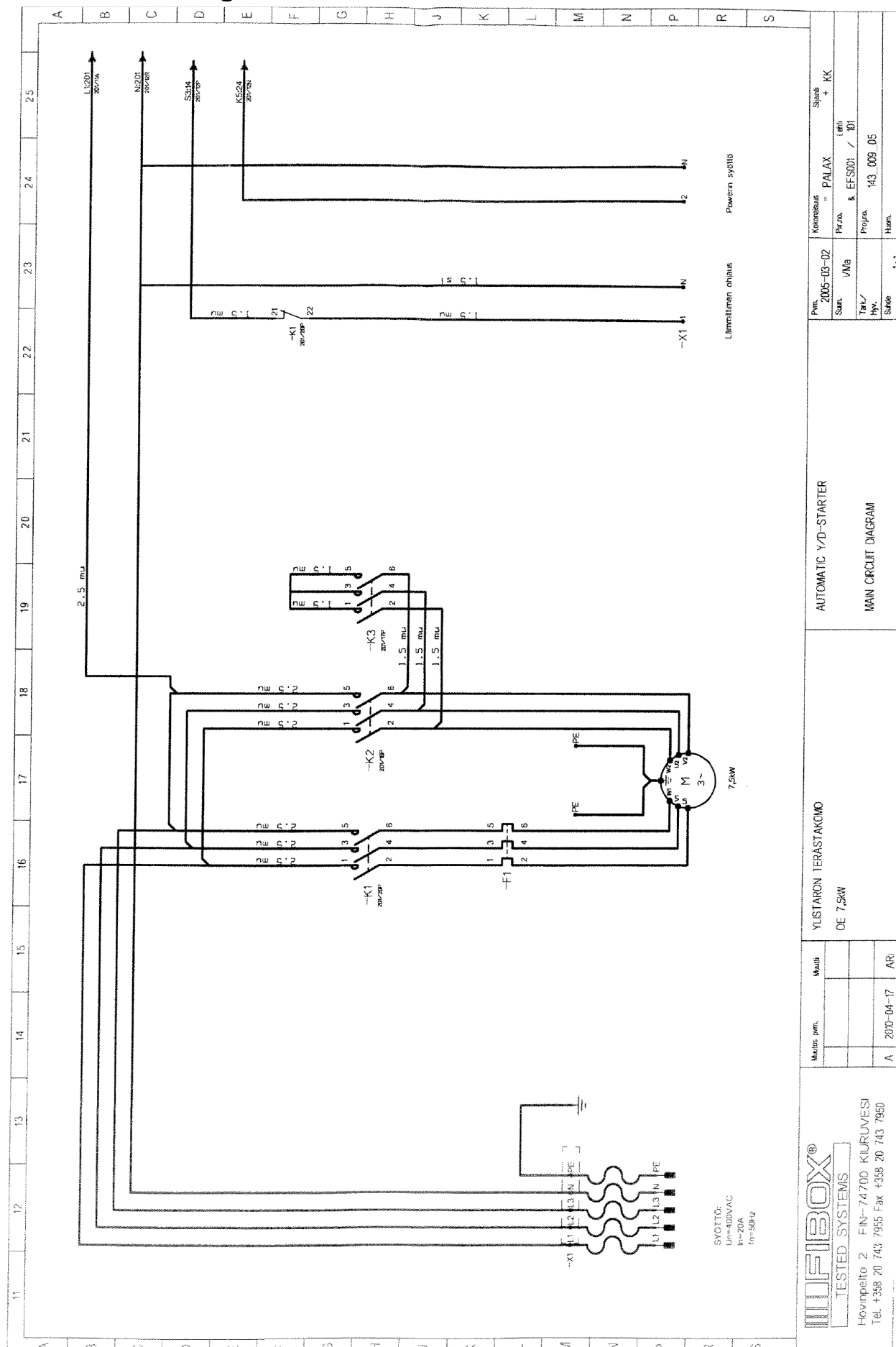

Hovinpöytä 2 FIN-74700 KILRUVESI
 Tel. +358 20 743 7955 Fax +358 20 743 7950

YLISTARON TERÄSTAKKO

OE 7,5kW

AUTOMATIC Y/D-STARTER

MAIN CIRCUIT DIAGRAM

Pvm.	2005-03-02	Korvotus	Palax	Sijainti	KK
Sart.	UNA	Proj.	EF5001 / 101		
Tek./Hyv.		Proj.	143_009_05		
Skala	1:1	Hann.			

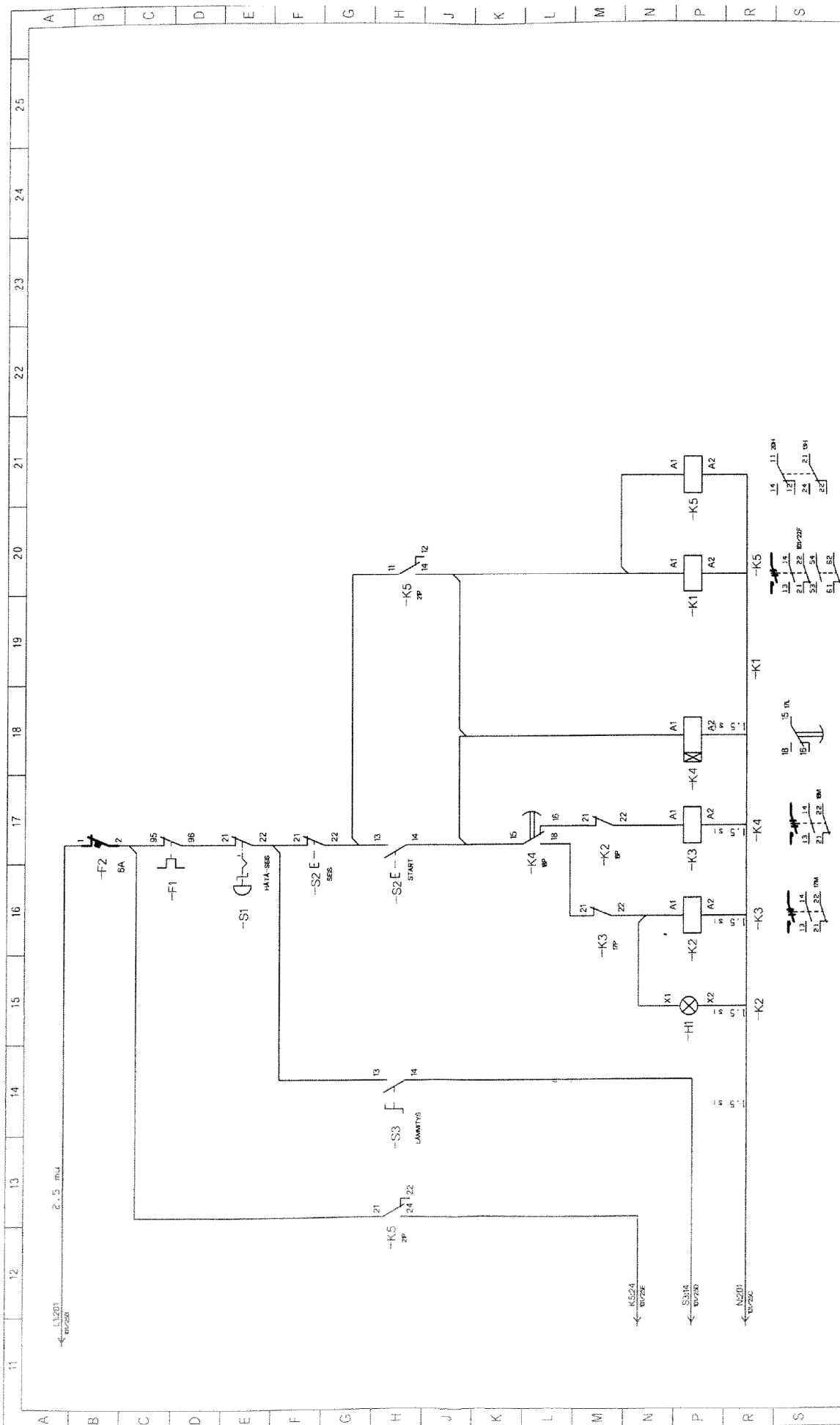

WIFIPIBOX® TESTED SYSTEMS Hovirpeltto 2 FIN-74700 KIJURUVESI Tel. +358 20 743 7955 Fax +358 20 743 7950		Muutt. p.m. A 2010-04-17	Malli AR1	YLISTARON TERASTAKOMO DE 7,5kW	AUTOMATIC Y/D-STARTER MAIN CIRCUIT DIAGRAM	Pvm. 2005-03-12 Sun. VML Task./Hyv. M3_003_05 Subje 1:1	Koneistus PALAX Sijainti + KK Päärak. & EFS001 / 201 Proj. M3_003_05 Huon. Järjestelmä/MEEM
---	--	-----------------------------	--------------	-----------------------------------	---	--	---